

FCC Information and Copyright

This equipment has been tested and found to comply with the limits of a Class B digital device, pursuant to Part 15 of the FCC Rules. These limits are designed to provide reasonable protection against harmful interference in a residential installation. This equipment generates, uses, and can radiate radio frequency energy and, if not installed and used in accordance with the instructions, may cause harmful interference to radio communications. There is no guarantee that interference will not occur in a particular installation.

The vendor makes no representations or warranties with respect to the contents here and specially disclaims any implied warranties of merchantability or fitness for any purpose. Further the vendor reserves the right to revise this publication and to make changes to the contents here without obligation to notify any party beforehand.

Duplication of this publication, in part or in whole, is not allowed without first obtaining the vendor's approval in writing.

The content of this user's manual is subject to be changed without notice and we will not be responsible for any mistakes found in this user's manual. All the brand and product names are trademarks of their respective companies.



Dichiarazione di conformità sintetica

Ai sensi dell'art. 2 comma 3 del D.M. 275 del 30/10/2002

Si dichiara che questo prodotto è conforme alle normative vigenti e soddisfa i requisiti essenziali richiesti dalle direttive

2004/108/CE, 2006/95/CE e 1999/05/CE

quando ad esso applicabili

Short Declaration of conformity

We declare this product is complying with the laws in force and meeting all the essential requirements as specified by the directives

2004/108/CE, 2006/95/CE and 1999/05/CE

whenever these laws may be applied

Table of Contents

Chapter 1: Introduction	1
1.1 Before You Start	1
1.2 Package Checklist	1
1.3 Motherboard Features	2
1.4 Rear Panel Connectors	3
1.5 Motherboard Layout	4
Chapter 2: Hardware Installation	5
2.1 Installing Central Processing Unit (CPU)	5
2.2 FAN Headers	7
2.3 Installing System Memory	8
2.4 Connectors and Slots	10
Chapter 3: Headers & Jumpers Setup	13
3.1 How to Setup Jumpers	13
3.2 Detail Settings	13
Chapter 4: AMD DUAL Graphics Technology	18
4.1 AMD Dual Graphics Technology Introduction	18
4.2 AMD Dual Graphics Requirement	18
4.3 AMD Dual Graphics Setup	19
Chapter 5: RAID Functions	20
5.1 Operating System	20
5.2 Raid Arrays	20
5.3 How RAID Works	20
Chapter 6: Useful Help	23
6.1 Driver Installation Note	23
6.2 Software	24
6.3 Extra Information	28
6.4 AMI BIOS Beep Code	30
6.5 Troubleshooting	31
Appendix: SPEC In Other Languages	32
German	32
French	34
Italian	36
Spanish	38
Portuguese	40
Polish	42
Russian	44
Arabic	46
Japanese	48

CHAPTER 1: INTRODUCTION

1.1 BEFORE YOU START

Thank you for choosing our product. Before you start installing the motherboard, please make sure you follow the instructions below:

- Prepare a dry and stable working environment with sufficient lighting.
- Always disconnect the computer from power outlet before operation.
- Before you take the motherboard out from anti-static bag, ground yourself properly by touching any safely grounded appliance, or use grounded wrist strap to remove the static charge.
- Avoid touching the components on motherboard or the rear side of the board unless necessary. Hold the board on the edge, do not try to bend or flex the board.
- Do not leave any unfastened small parts inside the case after installation. Loose parts will cause short circuits which may damage the equipment.
- Keep the computer from dangerous area, such as heat source, humid air and water.
- The operating temperatures of the computer should be 0 to 45 degrees Celsius.

1.2 PACKAGE CHECKLIST

- ✚ Serial ATA Cable X 4
- ✚ Rear I/O Panel for ATX Case X 1
- ✚ Installation Guide X 1
- ✚ User's Manual X1
- ✚ Fully Setup Driver DVD X1

Note: The package contents may be different due to area or your motherboard version.

1.3 MOTHERBOARD FEATURES

	<i>A75MH</i>	<i>A55MH</i>
CPU	Socket FM1 AMD A-Series / E2-Series processors AMD 64 Architecture enables 32 and 64 bit computing	Socket FM1 AMD A-Series / E2-Series processors AMD 64 Architecture enables 32 and 64 bit computing
Chipset	AMD A75	AMD A55
Super I/O	ITE 8728 Provides the most commonly used legacy Super I/O functionality Low Pin Count Interface Environment Control initiatives H/W Monitor ITE's "Smart Guardian" function	ITE 8728 Provides the most commonly used legacy Super I/O functionality Low Pin Count Interface Environment Control initiatives H/W Monitor ITE's "Smart Guardian" function
Main Memory	DDR3 DIMM Slots x 2 Max Memory Capacity 16GB Each DIMM supports 512MB/1GB/2GB/4GB/8GB DDR3 Dual Channel Mode DDR3 memory module Supports DDR3 800/1066/1333/1600/1866 Registered DIMM and ECC DIMM is not supported	DDR3 DIMM Slots x 2 Max Memory Capacity 16GB Each DIMM supports 512MB/1GB/2GB/4GB/8GB DDR3 Dual Channel Mode DDR3 memory module Supports DDR3 800/1066/1333/1600/1866 Registered DIMM and ECC DIMM is not supported
SATA3/ SATA2	Integrated Serial ATA Controller Data transfer rates up to 6 Gb/s SATA Version 3.0 specification compliant	Integrated Serial ATA Controller Data transfer rates up to 3 Gb/s SATA Version 2.0 specification compliant
LAN	Realtek RTL 8111E/8111F 10 / 100 / 1000 Mb/s auto negotiation Half / Full duplex capability	Realtek RTL 8111E/8111F 10 / 100 / 1000 Mb/s auto negotiation Half / Full duplex capability
Sound	VT1708B/ALC662 5.1 channels audio out High Definition Audio	VT1708B/ALC662 5.1 channels audio out High Definition Audio
USB3.0	A75	N/A
Slots	PCI Express Gen2 x16 slot x1 PCI Express Gen2 x1 slot x2 PCI slot x1	PCI Express Gen2 x16 slot x1 PCI Express Gen2 x1 slot x2 PCI slot x1
On Board Connector	SATA3 Connector x6 Front Panel Connector x1 Front Audio Connector x1 S/PDIF Out Connector x1	SATA2 Connector x6 Front Panel Connector x1 Front Audio Connector x1 S/PDIF Out Connector x1

	A75MH	A55MH
	CPU Fan Header x1	CPU Fan Header x1
	System Fan Header x1	System Fan Header x1
	CMOS clear Header x1	CMOS clear Header x1
	USB 2.0 Connector x2	USB 2.0 Connector x2
	USB 3.0 Connector x2	N/A
	Power Connector (24pin) x1	Power Connector (24pin) x1
	Power Connector (4pin) x1	Power Connector (4pin) x1
	Consumer IR Connector x1	Consumer IR Connector x1
	Printer Port Connector x1	Printer Port Connector x1
	Serial port Connector x1	Serial port Connector x1
Back Panel I/O	PS/2 Keyboard / Mouse x1	PS/2 Keyboard / Mouse x1
	HDMI Port x1	HDMI Port x1
	VGA Port x1	VGA Port x1
	DVI-D Port x1	DVI-D Port x1
	LAN Port x1	LAN Port x1
	USB 2.0 Port x2	USB 2.0 Port x4
	USB 3.0 Port x2	Audio Jack x3
	Audio Jack x3	
Board Size	200 mm(W) x 244 mm(L)	200 mm(W) x 244 mm(L)
Special Features	RAID 0 / 1 / 10 support	RAID 0 / 1 / 10 support
OS Support	Windows XP / Vista / 7 Biostar reserves the right to add or remove support for any OS With or without notice.	Windows XP / Vista / 7 Biostar reserves the right to add or remove support for any OS With or without notice.

1.4 REAR PANEL CONNECTORS

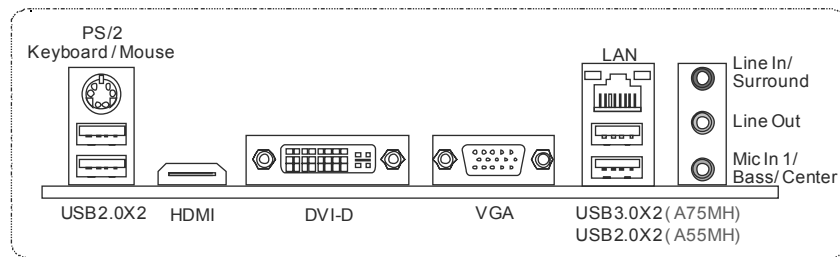

NOTE: USB3.0 ports are backward compatible with USB2.0/USB1.X devices.

1.5 MOTHERBOARD LAYOUT

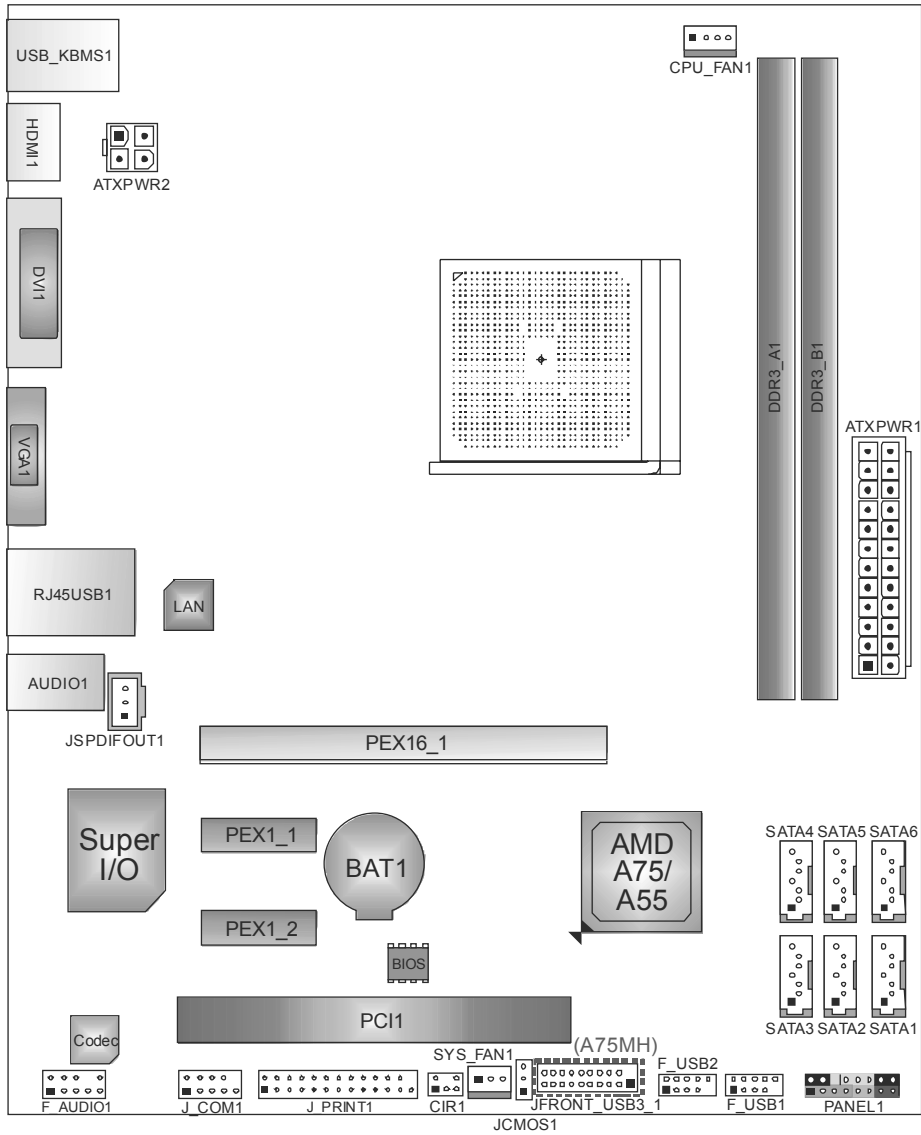

Note: ■ represents the 1st pin.

CHAPTER 2: HARDWARE INSTALLATION

2.1 INSTALLING CENTRAL PROCESSING UNIT (CPU)

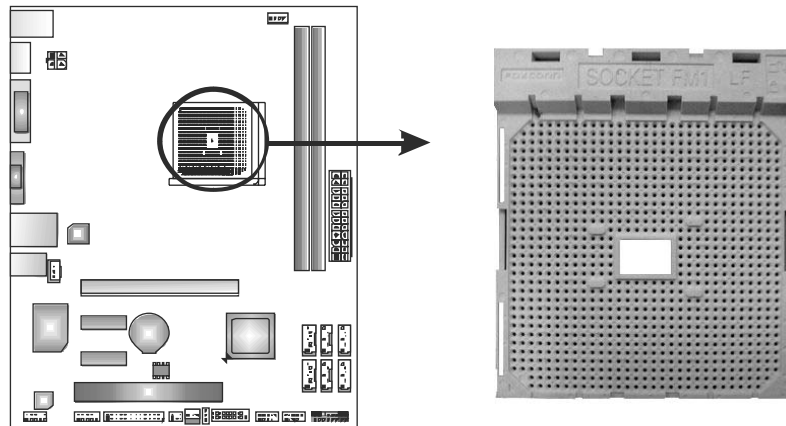

Step 1: Pull the lever toward direction A from the socket and then raise the lever up to a 90-degree angle.



Step 2: Look for the white triangle on socket, and the gold triangle on CPU should point towards this white triangle. The CPU will fit only in the correct orientation.



Motherboard Manual

Step 3: Hold the CPU down firmly, and then close the lever toward direct B to complete the installation.

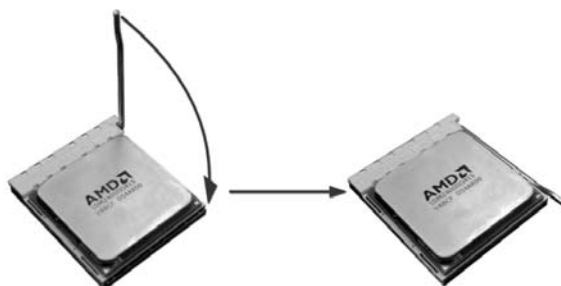

Step 4: Put the CPU Fan on the CPU and buckle it. Connect the CPU FAN power cable to the CPU_FAN1. This completes the installation.

2.2 FAN HEADERS

These fan headers support cooling-fans built in the computer. The fan cable and connector may be different according to the fan manufacturer. Connect the fan cable to the connector while matching the black wire to pin#1.

CPU_FAN1: CPU Fan Header

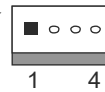
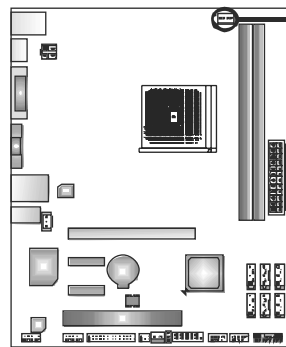

Pin	Assignment
1	Ground
2	+12V
3	FAN RPM rate sense
4	Smart Fan Control (By Fan)

SYS_FAN1: System Fan Header

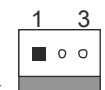
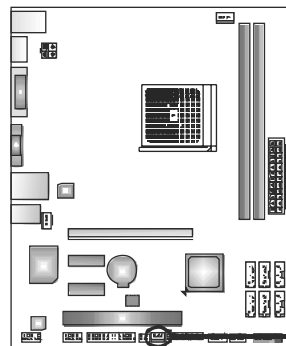

Pin	Assignment
1	Ground
2	+12V
3	FAN RPM rate sense

Note:

CPU_FAN1 supports 4-pin head connector. SYS_FAN1 supports 3-pin head connector. When connecting with wires onto connectors, please note that the red wire is the positive and should be connected to pin#2, and the black wire is Ground and should be connected to GND.

2.3 INSTALLING SYSTEM MEMORY

A. Memory Modules

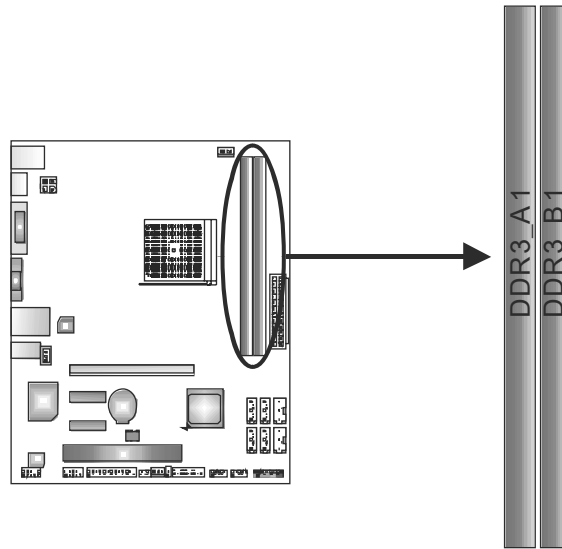

1. Unlock a DIMM slot by pressing the retaining clips outward. Align a DIMM on the slot such that the notch on the DIMM matches the

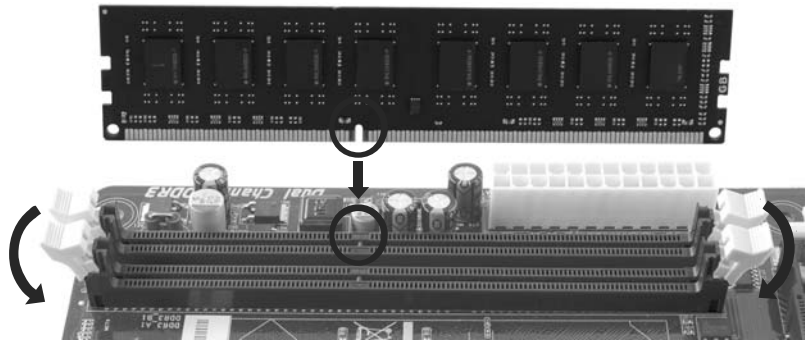

2. Insert the DIMM vertically and firmly into the slot until the retaining chip snap back in place and the DIMM is properly seated.

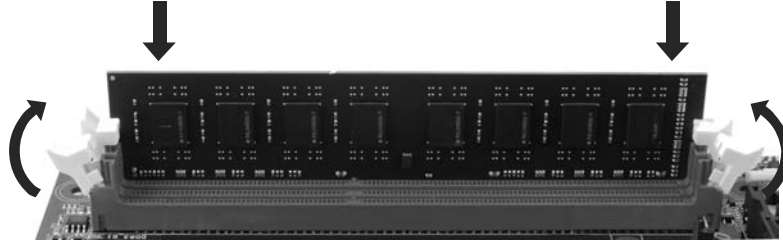

Note:

If the DIMM does not go in smoothly, do not force it. Pull it all the way out and try again.

B. Memory Capacity

DIMM Socket Location	DDR3 Module	Total Memory Size
DDR3_A1	512MB/1GB/2GB/4GB/8GB	Max is 16GB.
DDR3_B1	512MB/1GB/2GB/4GB/8GB	

C. Dual Channel Memory installation

Please refer to the following requirements to activate Dual Channel function:

Install memory module of the same density in pairs, shown in the table

Dual Channel Status	DDR3_A1	DDR3_B1
Disabled	X	O
Disabled	O	X
Enabled	O	O

(O means memory installed, X means memory not installed.)

The DRAM bus width of the memory module must be the same (x8 or x16)

D. DDR Speed Support

Please refer to the following table for DDR speed reference:

# of DIMM per Channel	# of Ranks per DIMM	Max DDR Speed Grade for 1.50V DIMM
1 of 1 UDIMM	xR	DDR3-1866
1 of 2 UDIMMs	xR	DDR3-1600 / DDR3-1333

Note:

✦ xR: Single or double side memory module

2.4 CONNECTORS AND SLOTS

SATA1~SATA6: Serial ATA Connectors

A75MH/A55MH has a PCI to SATA Controller with 6 channels SATA interface. A75MH satisfies the SATA 3.0 spec and with transfer rate of 6.0Gb/s; A55MH satisfies the SATA 2.0 spec and with transfer rate of 3.0Gb/s.

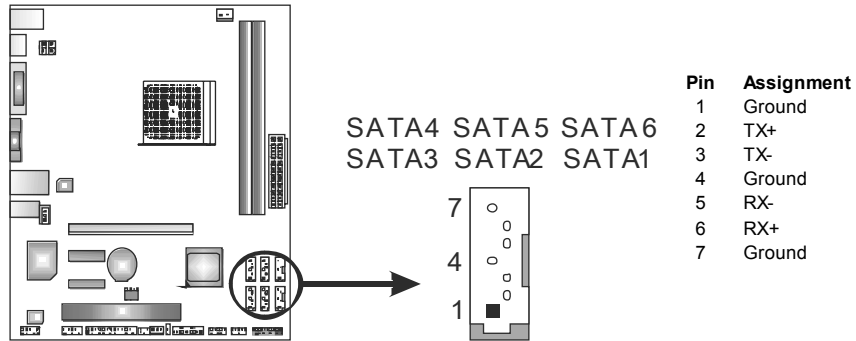

ATXPWR2: ATX Power Source Connector

This connector will provide +12V to CPU power circuit.

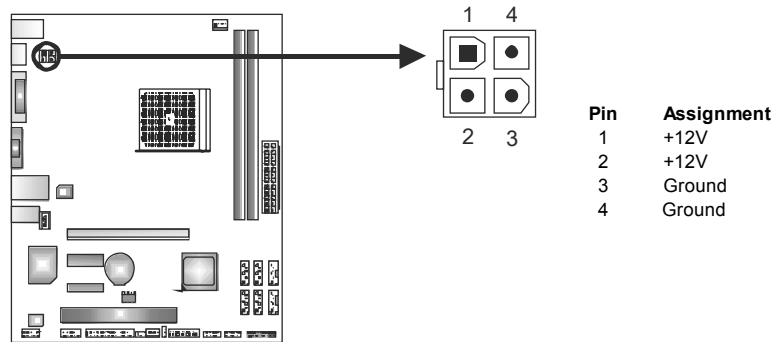

ATXPWR1: ATX Power Source Connector

This connector allows user to connect 24-pin power connector on the ATX power supply.

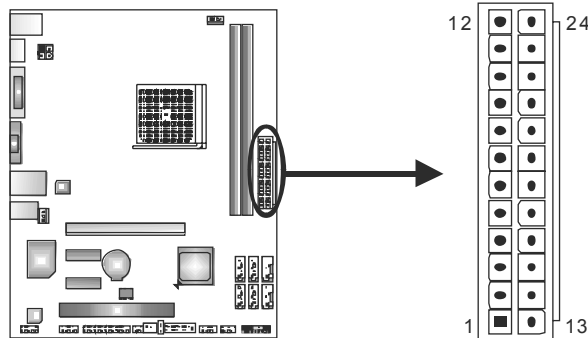

Pin	Assignment	Pin	Assignment
13	+3.3V	1	+3.3V
14	-12V	2	+3.3V
15	Ground	3	Ground
16	PS_ON	4	+5V
17	Ground	5	Ground
18	Ground	6	+5V
19	Ground	7	Ground
20	NC	8	PW_OK
21	+5V	9	Standby Voltage+5V
22	+5V	10	+12V
23	+5V	11	+12V
24	Ground	12	+3.3V

Note:

Before you power on the system, please make sure that both ATXPWR1 and ATXPWR2 connectors have been plugged-in.

PCI1: Peripheral Component Interconnect Slot

This motherboard is equipped with 1 standard PCI slot. PCI stands for Peripheral Component Interconnect, and it is a bus standard for expansion cards.

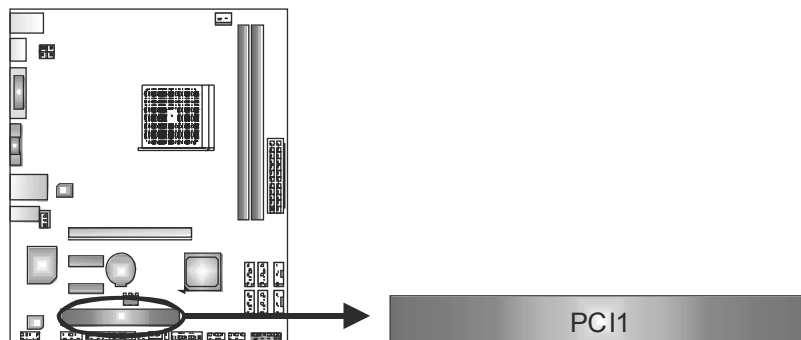

PEX16_1: PCI-Express Gen2 x16 Slot

- PCI-Express 2.0 compliant.
- Maximum theoretical realized bandwidth of 8GB/s simultaneously per direction, for an aggregate of 16GB/s totally.
- PCI-Express Gen2 supports a raw bit-rate of 5.0Gb/s on the data pins.
- 2X bandwidth over the PCI-Express 1.1 architecture.

PEX1_1/PEX1_2: PCI-Express Gen2 x1 Slots

- PCI-Express 2.0 compliant.
- Data transfer bandwidth up to 500MB/s per direction; 1GB/s in total.
- PCI-Express supports a raw bit-rate of 2.5Gb/s on the data pins.

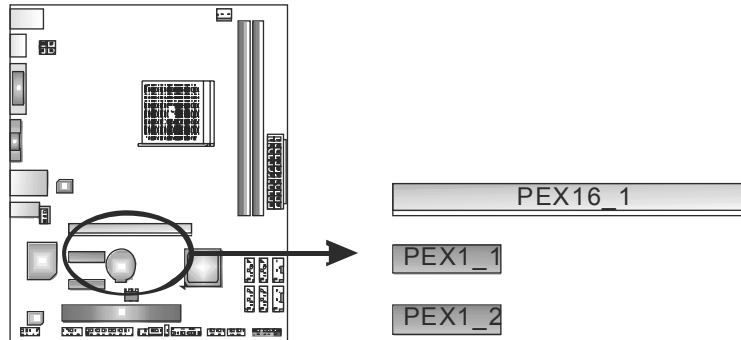

CHAPTER 3: HEADERS & JUMPERS SETUP

3.1 HOW TO SETUP JUMPERS

The illustration shows how to set up jumpers. When the jumper cap is placed on pins, the jumper is “close”, if not, that means the jumper is “open”.

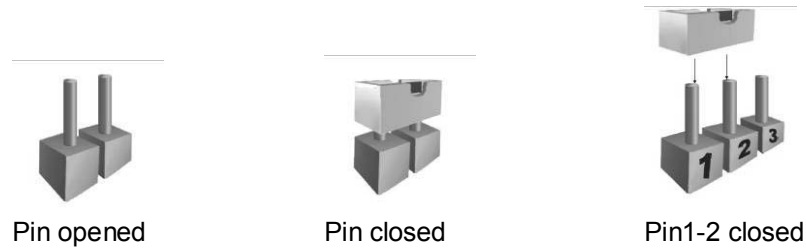

3.2 DETAIL SETTINGS

PANEL1: Front Panel Header

This 16-pin connector includes Power-on, Reset, HDD LED, Power LED, and speaker connection. It allows user to connect the PC case's front panel switch functions.

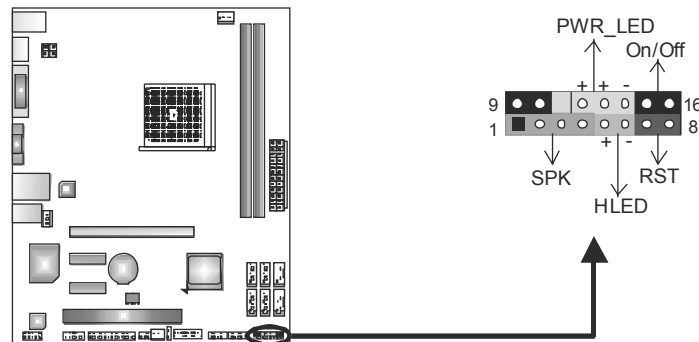

Pin	Assignment	Function	Pin	Assignment	Function
1	+5V	Speaker Connector	9	N/A	N/A
2	N/A		10	N/A	N/A
3	N/A		11	N/A	N/A
4	Speaker	Hard drive LED	12	Power LED (+)	Power LED
5	HDD LED (+)		13	Power LED (+)	
6	HDD LED (-)		14	Power LED (-)	
7	Ground	Reset button	15	Power button	Power-on button
8	Reset control		16	Ground	

F_USB1/F_USB2: Headers for USB 2.0 Ports at Front Panel

This header allows user to connect additional USB cable on the PC front panel, and also can be connected with internal USB devices, like USB card reader.

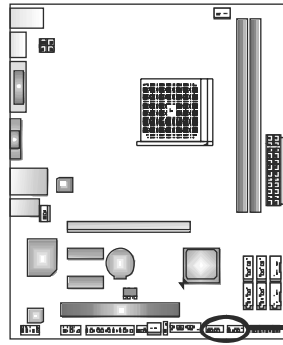

Pin	Assignment
1	+5V (fused)
2	+5V (fused)
3	USB-
4	USB-
5	USB+
6	USB+
7	Ground
8	Ground
9	NC
10	Key

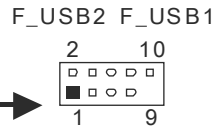

JFRONT_USB3_1: Header for USB 3.0 Ports at Front Panel (A75MH)

This header allows user to connect additional USB cable on the PC front panel, and also can be connected with internal USB devices, like USB card reader.

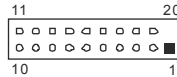
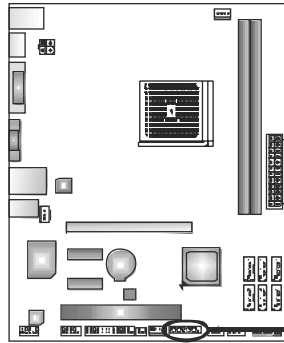

Pin	Assignment	Pin	Assignment
1	VBUS0	11	D2+
2	SSRX1-	12	D2-
3	SSRX1+	13	Ground
4	Ground	14	SSTX2+
5	SSTX1-	15	SSTX2-
6	SSTX1+	16	Ground
7	Ground	17	SSRX2+
8	D1-	18	SSRX2-
9	D1+	19	VBUS1
10	ID	20	Key

JSPDIFOUT1: Digital Audio-out Connector

This connector allows user to connect the PCI bracket SPDIF output header.

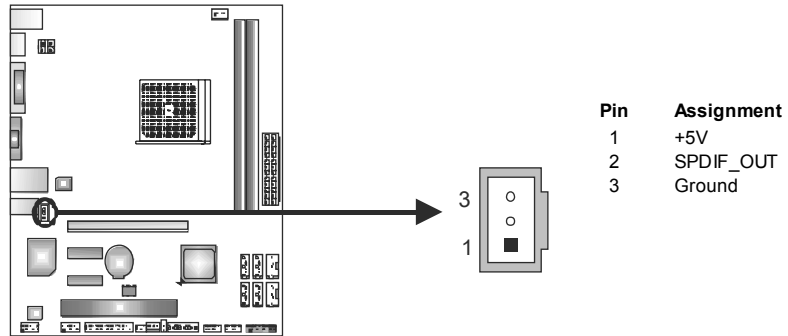

F_AUDIO1: Front Panel Audio Header

This header allows user to connect the front audio output cable with the PC front panel. This header allows only HD audio front panel connector; AC'97 connector is not acceptable.

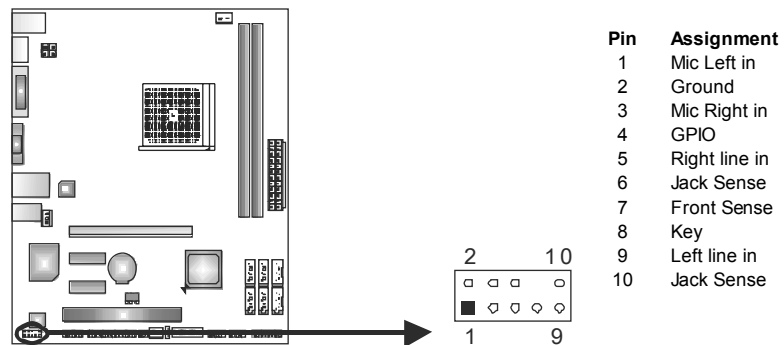

JCMOS1: Clear CMOS Header

Placing the jumper on pin2-3, it allows user to restore the BIOS safe setting and the CMOS data. Please carefully follow the procedures to avoid damaging the motherboard.

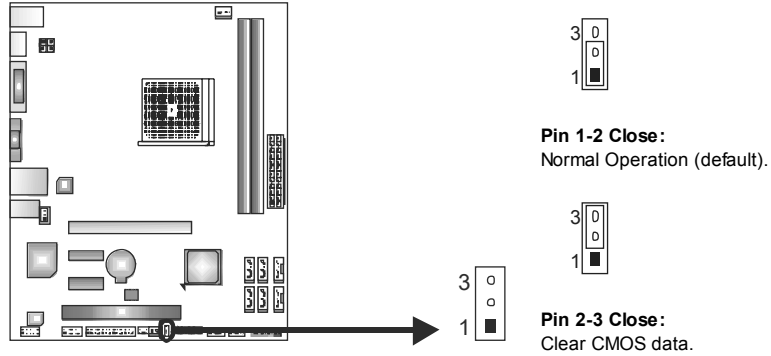

※ Clear CMOS Procedures:

1. Remove AC power line.
2. Set the jumper to "Pin 2-3 close".
3. Wait for five seconds.
4. Set the jumper to "Pin 1-2 close".
5. Power on the AC.
6. Load Optimal Defaults and save settings in CMOS.

J_COM1: Serial Port Connector

The motherboard has a Serial Port Connector for connecting RS-232 Port.

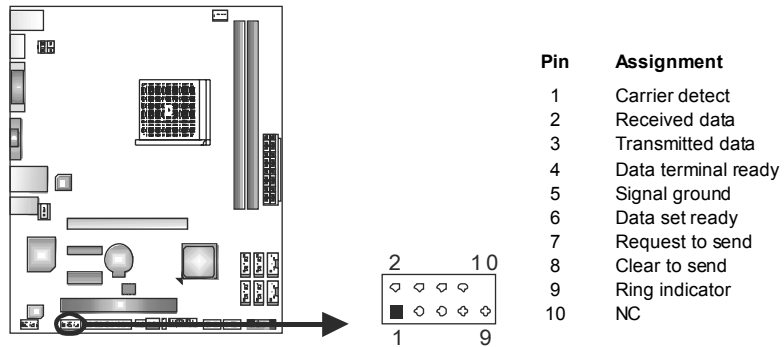

J_PRINT1: Printer Port Connector

This header allows you to connect printer on the PC.

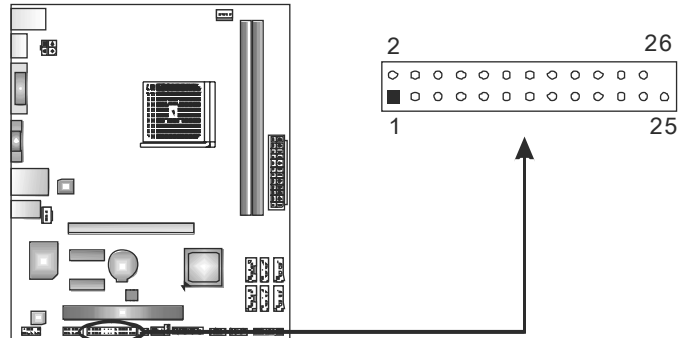

Pin	Assignment	Pin	Assignment
1	-Strobe	14	Ground
2	-ALF	15	Data 6
3	Data 0	16	Ground
4	-Error	17	Data 7
5	Data 1	18	Ground
6	-Init	19	-ACK
7	Data 2	20	Ground
8	-Scltin	21	Busy
9	Data 3	22	Ground
10	Ground	23	PE
11	Data 4	24	Ground
12	Ground	25	SCLT
13	Data 5	26	Key

CIR1: Consumer IR Connector

This header is for infrared remote control and communication.

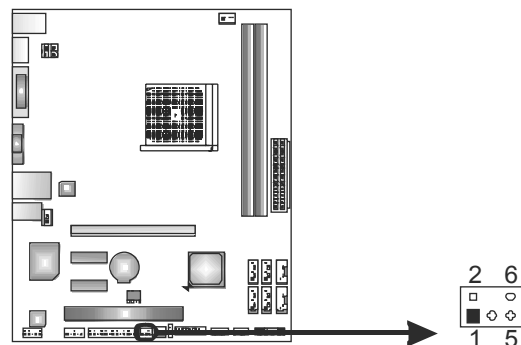

Pin	Assignment
1	IrDA serial input
2	Ground
3	Ground
4	Key
5	IrDA serial output
6	IR Power

CHAPTER 4: AMD DUAL GRAPHICS TECHNOLOGY

4.1 AMD DUAL GRAPHICS TECHNOLOGY INTRODUCTION

When user adds a PCIE display adapter, it can be integrated with IGD to show better performance. To make the two video devices work simultaneously and normally, please refer to the following setting.

4.2 AMD DUAL GRAPHICS REQUIREMENT

- **Operating System:** Windows Vista / Windows 7
- **Supported DUAL Graphics Combinations:**

GFX \ APU	A4-Series HD 6410D	A6-Series HD 6530D	A8-Series™ HD 6550D
HD 6670	Attach Only (No DG)	Y	Y
HD 6570	Attach Only (No DG)	Y	Y
HD 6450	Y	Y	Y
HD 6350	Y	Attach Only (No DG)	Attach Only (No DG)

Note:

- ✦ “Attach Only (No DG)” indicates supported discrete graphics attachment without Dual Graphics.
- ✦ E-Series CPU do not support Dual Graphics.

Notice:

Single Channel or unbalanced memory does not support Dual Graphic function. Please use at least DDR3-1333 4G (2G+2G).

NOTE

The information described above in this manual is for your reference only and the actual information and settings on board may be different from this manual. For further AMD Dual Graphics information, please visit the following website:

<http://www.amd.com>

4.3 AMD DUAL GRAPHICS SETUP

Step 1: Insert Dual Graphics-Ready graphics card into PEX16_1 slot.

Step 2: Set the BIOS setting as follows:
[Chipset]→[North Bridge]→[Surround View]→[Enabled]



Step 3: Install Driver CD Chipset Driver, and reboot the system. Activate AMD VISION Engine Control Center to make sure CrossFire has been enabled.

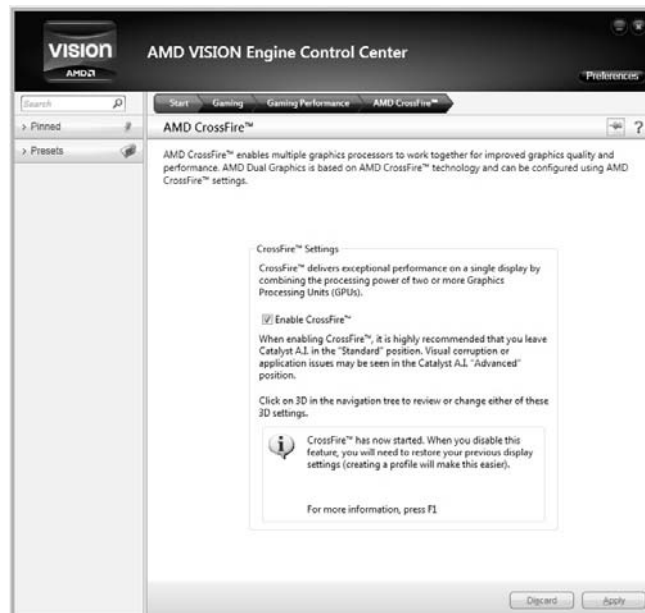

CHAPTER 5: RAID FUNCTIONS

5.1 OPERATING SYSTEM

Supports Windows XP, Windows Vista, and Windows 7.

5.2 RAID ARRAYS

RAID supports the following types of RAID arrays:

RAID 0: RAID 0 defines a disk striping scheme that improves disk read and write times for many applications.

RAID 1: RAID 1 defines techniques for mirroring data.

RAID 10: RAID 10 combines the techniques used in RAID 0 and RAID 1.

5.3 How RAID WORKS

RAID 0:

The controller “stripes” data across multiple drives in a RAID 0 array system. It breaks up a large file into smaller blocks and performs disk reads and writes across multiple drives in parallel. The size of each block is determined by the stripe size parameter, which you set during the creation of the RAID set based on the system environment. This technique reduces overall disk access time and offers high bandwidth.

Features and Benefits

- **Drives:** Minimum 2, and maximum is up to 6 or 8. Depending on the platform.
- **Uses:** Intended for non-critical data requiring high data throughput, or any environment that does not require fault tolerance.
- **Benefits:** provides increased data throughput, especially for large files. No capacity loss penalty for parity.
- **Drawbacks:** Does not deliver any fault tolerance. If any drive in the array fails, all data is lost.
- **Fault Tolerance:** No.

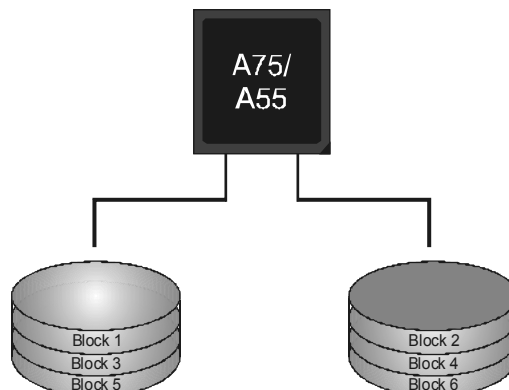

RAID 1:

Every read and write is actually carried out in parallel across 2 disk drives in a RAID 1 array system. The mirrored (backup) copy of the data can reside on the same disk or on a second redundant drive in the array. RAID 1 provides a hot-standby copy of data if the active volume or drive is corrupted or becomes unavailable because of a hardware failure. RAID techniques can be applied for high-availability solutions, or as a form of automatic backup that eliminates tedious manual backups to more expensive and less reliable media.

Features and Benefits

- **Drives:** Minimum 2, and maximum is 2.
- **Uses:** RAID 1 is ideal for small databases or any other application that requires fault tolerance and minimal capacity.
- **Benefits:** Provides 100% data redundancy. Should one drive fail, the controller switches to the other drive.
- **Drawbacks:** Requires 2 drives for the storage space of one drive. Performance is impaired during drive rebuilds.
- **Fault Tolerance:** Yes.

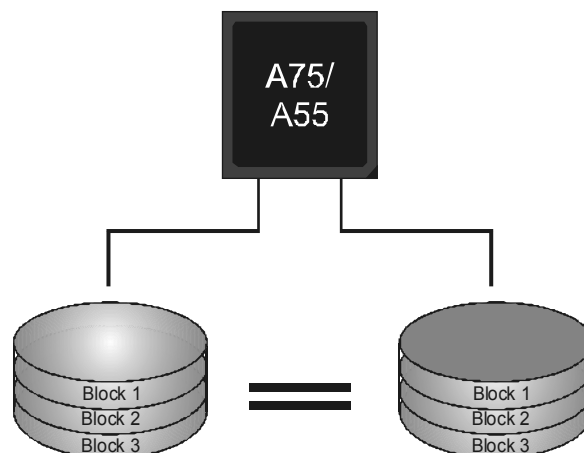

RAID 10:

RAID 1 drives can be striped using RAID 0 techniques. Resulting in a RAID 10 solution for improved resiliency, performance and rebuild performance.

Features and Benefits

- **Drives:** Minimum 4, and maximum is 6 or 8, depending on the platform.
- **Benefits:** Optimizes for both fault tolerance and performance, allowing for automatic redundancy. May be simultaneously used with other RAID levels in an array, and allows for spare disks.
- **Drawbacks:** Requires twice the available disk space for data redundancy, the same as RAID level 1.
- **Fault Tolerance:** Yes.

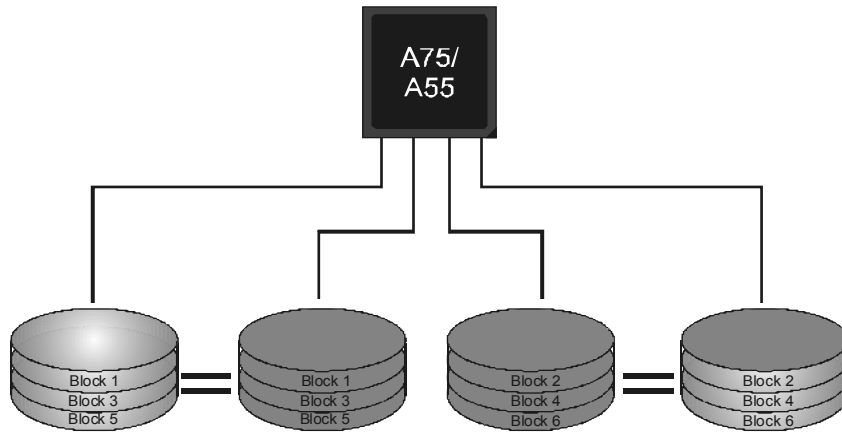

CHAPTER 6: USEFUL HELP

6.1 DRIVER INSTALLATION NOTE

After you installed your operating system, please insert the Fully Setup Driver CD into your optical drive and install the driver for better system performance.

You will see the following window after you insert the CD

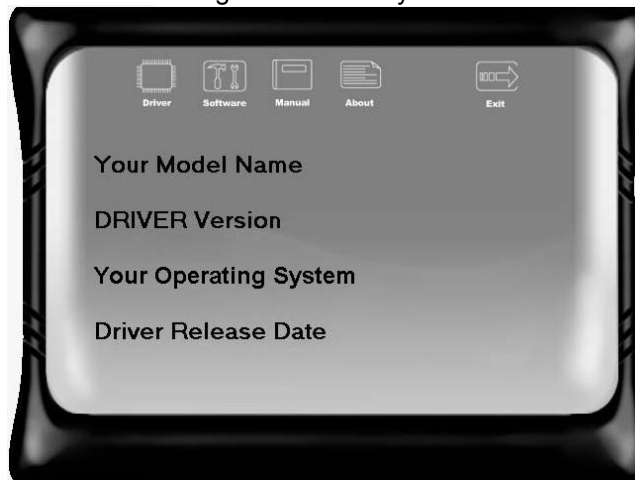

The setup guide will auto detect your motherboard and operating system.

Note:

If this window didn't show up after you insert the Driver CD, please use file browser to locate and execute the file **SETUP.EXE** under your optical drive.

A. Driver Installation

To install the driver, please click on the Driver icon. The setup guide will list the compatible driver for your motherboard and operating system. Click on each device driver to launch the installation program.

B. Software Installation

To install the software, please click on the Software icon. The setup guide will list the software available for your system, click on each software title to launch the installation program.

C. Manual

Aside from the paperback manual, we also provide manual in the Driver CD. Click on the Manual icon to browse for available manual.

Note:

You will need Acrobat Reader to open the manual file. Please download the latest version of Acrobat Reader software from

<http://www.adobe.com/products/acrobat/readstep2.html>

6.2 SOFTWARE

Installing Software

1. Insert the Setup CD to the optical drive. The drivers installation program would appear if the Autorun function has been enabled.
2. Select **Software Installation**, and then click on the respective software title.
3. Follow the on-screen instructions to complete the installation.

Launching Software

After the installation process, you will see the software icon “eHOT Line” / “BIOS Update” appears on the desktop. Double-click the icon to launch the utility.

eHot-Line (Optional)

eHot-Line is a convenient utility that helps you to contact with our Tech-Support system. This utility will collect the system information which is useful for analyzing the problem you may have encountered, and then send these information to our tech-support department to help you fix the problem.

 Before you use this utility, please set Outlook Express as your default e-mail client application program.

*represents important information that you must provide. Without this information, you may not be able to send out the mail.

This block will show the information which would be collected in the mail.

*Describe condition of your system.

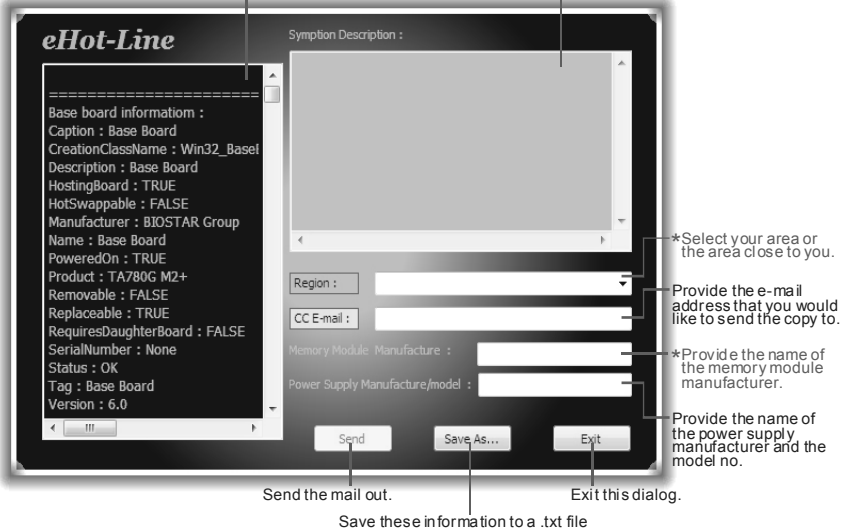

The screenshot shows the eHot-Line utility window. On the left, a text box displays system information: Base board information: Caption: Base Board, CreationClassName: Win32_Base, Description: Base Board, HostingBoard: TRUE, HotSwappable: FALSE, Manufacturer: BIOSTAR Group, Name: Base Board, PoweredOn: TRUE, Product: TA780G M2+, Removable: FALSE, Replaceable: TRUE, RequiresDaughterBoard: FALSE, SerialNumber: None, Status: OK, Tag: Base Board, Version: 6.0. On the right, there is a 'Symptom Description' text area, a 'Region' dropdown menu, a 'CC E-mail' text box, and two more text boxes for 'Memory Module Manufacture' and 'Power Supply Manufacture/model'. At the bottom are 'Send', 'Save As...', and 'Exit' buttons. Annotations with arrows point to these elements: 'This block will show the information which would be collected in the mail.' points to the system information text box; '*Describe condition of your system.' points to the Symptom Description text area; '*Select your area or the area close to you.' points to the Region dropdown; 'Provide the e-mail address that you would like to send the copy to.' points to the CC E-mail text box; '*Provide the name of the memory module manufacturer.' points to the Memory Module Manufacture text box; 'Provide the name of the power supply manufacturer and the model no.' points to the Power Supply Manufacture/model text box; 'Send the mail out.' points to the Send button; 'Exit this dialog.' points to the Exit button; and 'Save these in formation to a .txt file' points to the Save As... button.

After filling up this information, click **“Send”** to send the mail out. A warning dialog would appear asking for your confirmation; click **“Send”** to confirm or **“Do Not Send”** to cancel.



If you want to save this information to a .txt file, click **“Save As...”** and then you will see a saving dialog appears asking you to enter file name.

Enter the file name and then click **“Save”**. Your system information will be saved to a .txt file.

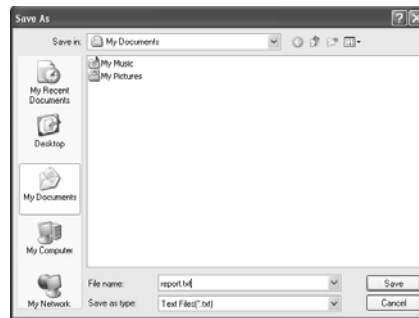

Open the saved .txt file, you will see your system information including motherboard/BIOS/CPU/video/device/OS information. This information is also concluded in the sent mail.



We will not share customer’s data with any other third parties, so please feel free to provide your system information while using eHot-Line service.



If you are not using Outlook Express as your default e-mail client application, you may need to save the system information to a .txt file and send the file to our tech support with other e-mail application. Go to the following web <http://www.biostar.com.tw/app/en-us/about/contact.php> for getting our contact information.

BIOS Update

BIOS Update is a convenient utility which allows you to update your motherboard BIOS under Windows system.

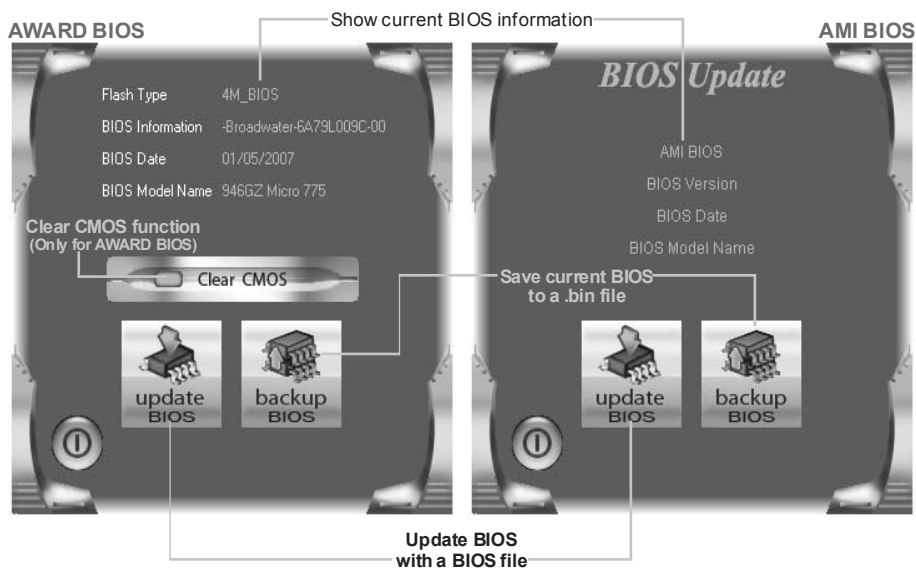

<Backup BIOS>

Once click on this button, the saving dialog will show. Choose the position to save file and enter file name. (We recommend that the file name should be English/number and no longer than 7 characters.) Then click **Save**.

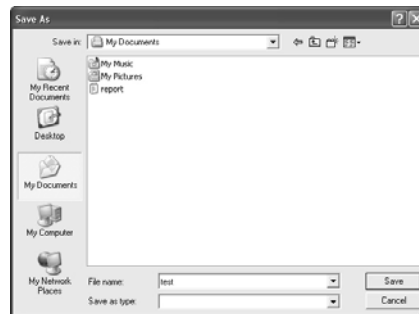

<Update BIOS>

Before doing this, please download the proper BIOS file from the website.

For AWARD BIOS, update BIOS procedure should be run with Clear CMOS function, so please check on Clear CMOS first.

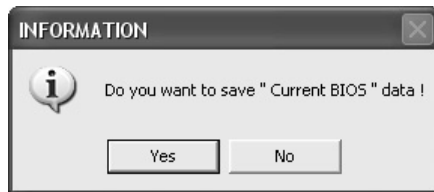

Then click Update BIOS button, a dialog will show for asking you backup current BIOS. Click **Yes** for BIOS backup and refer to the Backup BIOS procedure; or click **No** to skip this procedure.

After the BIOS Backup procedure, the open dialog will show for requesting the BIOS file which is going to be updated. Please choose the proper BIOS file for updating, then click on **Open**.

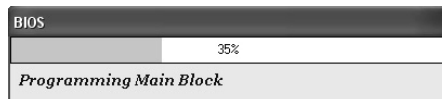

The utility will update BIOS with the proper BIOS file, and this process may take minutes. Please do not open any other applications during this process.

After the BIOS Update process, click on **OK** to restart the system.

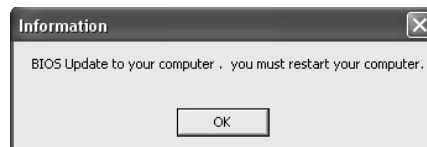

While the system boots up and the full screen logo shows, press  <Delete> key to enter BIOS setup.

In the BIOS setup, use the **Load Optimized Defaults** function and then **Save and Exit Setup** to exit BIOS setup. BIOS Update is completed.



All the information and content above about the software are subject to be changed without notice. For better performance, the software is being continuously updated. The information and pictures described above are for your reference only. The actual information and settings on board may be slightly different from this manual.

6.3 EXTRA INFORMATION

CPU Overheated

If the system shutdown automatically after power on system for seconds, that means the CPU protection function has been activated.

When the CPU is over heated, the motherboard will shutdown automatically to avoid a damage of the CPU, and the system may not power on again.

In this case, please double check:

1. The CPU cooler surface is placed evenly with the CPU surface.
2. CPU fan is rotated normally.
3. CPU fan speed is fulfilling with the CPU speed.

After confirmed, please follow steps below to relief the CPU protection function.

1. Remove the power cord from power supply for seconds.
2. Wait for seconds.
3. Plug in the power cord and boot up the system.

Or you can:

1. Clear the CMOS data.
(See "Close CMOS Header: JCMOS1" section)
2. Wait for seconds.
3. Power on the system again.

BIO-Flasher

BIO-Flasher is a BIOS flashing utility providing you an easy and simple way to update your BIOS via USB pen drive or floppy disk.

The BIO-Flasher is built in the BIOS chip. To enter the utility, **press <F12> during the Power-On Self Tests (POST)** procedure while booting up.

Updating BIOS with BIO-Flasher

1. Go to the website to download the latest BIOS file for the motherboard.
2. Then, save the BIOS file into a USB pen drive or a floppy disk.
3. Insert the USB pen drive or the floppy disk that contains the BIOS file to the USB port or the floppy disk drive.
4. Power on or reset the computer and then press **<F12>** during the **POST** process. A select dialog as the picture on the right appears. Select the device contains the BIOS file and press **<Enter>** to enter the utility.

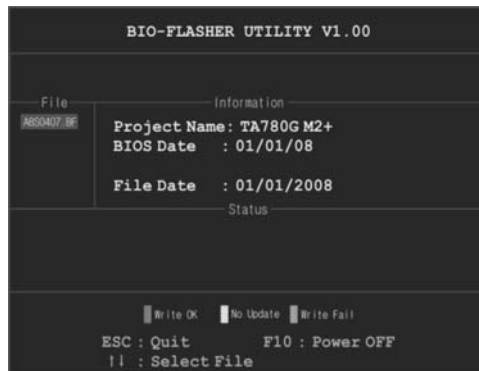

5. The utility will show the BIOS files and their respective information. Select the proper BIOS file and press **<Enter>** then **<Y>** to perform the BIOS update process.

6. After the update process, the utility will ask you to reboot the system. Press **<Y>** to proceed. BIOS update completes.



- This utility only allows storage device with FAT32/16 format and single partition.
- Shutting down or resetting the system while updating the BIOS will lead to system boot failure.

6.4 AMI BIOS BEEP CODE

Boot Block Beep Codes

Number of Beeps	Description
1	No media present. (Insert diskette in floppy drive A:)
2	"AMIBOOT.ROM" file not found in root directory of diskette in A:
3	Insert next diskette if multiple diskettes are used for recovery
4	Flash Programming successful
5	File read error
7	No Flash EPROM detected
10	Flash Erase error
11	Flash Program error
12	"AMIBOOT.ROM" file size error
13	BIOS ROM image mismatch (file layout does not match image present in flash device)

POST BIOS Beep Codes

Number of Beeps	Description
1	Memory refresh timer error
3	Base memory read/write test error
6	Keyboard controller BAT command failed
7	General exception error (processor exception interrupt error)
8	Display memory error (system video adapter)

Troubleshooting POST BIOS Beep Codes

Number of Beeps	Troubleshooting Action
1, 3	Reseat the memory, or replace with known good modules.
6, 7	<p>Fatal error indicating a serious problem with the system. Consult your system manufacturer. Before declaring the motherboard beyond all hope, eliminate the possibility of interference by a malfunctioning add-in card. Remove all expansion cards except the video adapter.</p> <ul style="list-style-type: none"> ● If beep codes are generated when all other expansion cards are absent, consult your system manufacturer's technical support. ● If beep codes are not generated when all other expansion cards are absent, one of the add-in cards is causing the malfunction. Insert the cards back into the system one at a time until the problem happens again. This will reveal the malfunctioning card.
8	If the system video adapter is an add-in card, replace or reseat the video adapter. If the video adapter is an integrated part of the system board, the board may be faulty.

6.5 TROUBLESHOOTING

Probable	Solution
<ol style="list-style-type: none"> 1. There is no power in the system. Power LED does not shine; the fan of the power supply does not work 2. Indicator light on keyboard does not shine. 	<ol style="list-style-type: none"> 1. Make sure power cable is securely plugged in. 2. Replace cable. 3. Contact technical support.
System is inoperative. Keyboard lights are on, power indicator lights are lit, and hard drives are running.	Using even pressure on both ends of the DIMM, press down firmly until the module snaps into place.
System does not boot from a hard disk drive, but can be booted from optical drive.	<ol style="list-style-type: none"> 1. Check cable running from disk to disk controller board. Make sure both ends are securely plugged in; check the drive type in the standard CMOS setup. 2. Backing up the hard drive is extremely important. All hard disks are capable of breaking down at any time.
System only boots from an optical drive. Hard disks can be read, applications can be used, but system fails to boot from a hard disk.	<ol style="list-style-type: none"> 1. Back up data and applications files. 2. Reformat the hard drive. Re-install applications and data using backup disks.
Screen message shows "Invalid Configuration" or "CMOS Failure."	Review system's equipment. Make sure correct information is in setup.
System cannot boot after user installs a second hard drive.	<ol style="list-style-type: none"> 1. Set master/slave jumpers correctly. 2. Run SETUP program and select correct drive types. Call the drive manufacturers for compatibility with other drives.

APPENDIX: SPEC IN OTHER LANGUAGES

GERMAN

	<i>A75MH</i>	<i>A55MH</i>
CPU	<p>Socket FM1</p> <p>AMD A-Series / E2-Series Prozessoren</p> <p>Die AMD 64-Architektur unterstützt eine 32-Bit- und 64-Bit-Datenverarbeitung</p>	<p>Socket FM1</p> <p>AMD A-Series / E2-Series Prozessoren</p> <p>Die AMD 64-Architektur unterstützt eine 32-Bit- und 64-Bit-Datenverarbeitung</p>
Chipsatz	AMD A75	AMD A55
Super E/A	<p>ITE 8728</p> <p>Bietet die häufig verwendeten alten Super E/A-Funktionen.</p> <p>Low Pin Count-Schnittstelle</p> <p>Umgebungskontrolle, Hardware-Überwachung</p> <p>"Smart Guardian"-Funktion von ITE</p>	<p>ITE 8728</p> <p>Bietet die häufig verwendeten alten Super E/A-Funktionen.</p> <p>Low Pin Count-Schnittstelle</p> <p>Umgebungskontrolle, Hardware-Überwachung</p> <p>"Smart Guardian"-Funktion von ITE</p>
Arbeitsspeicher	<p>DDR3 DIMM-Steckplätze x 2</p> <p>Max. 16GB Arbeitsspeicher</p> <p>Jeder DIMM unterstützt</p> <p>512MB/1GB/2GB/4GB/8GB DDR3.</p> <p>Dual-Kanal DDR3 Speichermodul</p> <p>Unterstützt DDR3 800/1066/1333/1600/1866 registrierte DIMMs. ECC DIMMs werden nicht unterstützt.</p>	<p>DDR3 DIMM-Steckplätze x 2</p> <p>Max. 16GB Arbeitsspeicher</p> <p>Jeder DIMM unterstützt</p> <p>512MB/1GB/2GB/4GB/8GB DDR3.</p> <p>Dual-Kanal DDR3 Speichermodul</p> <p>Unterstützt DDR3 800/1066/1333/1600/1866 registrierte DIMMs. ECC DIMMs werden nicht unterstützt.</p>
SATA3/ SATA2	<p>Integrierter Serial ATA-Controller</p> <p>Datentransferrate bis zu 6 Gb/s</p> <p>Konform mit der SATA-Spezifikation Version 3.0</p>	<p>Integrierter Serial ATA-Controller</p> <p>Datentransferrate bis zu 3 Gb/s</p> <p>Konform mit der SATA-Spezifikation Version 2.0</p>
LAN	<p>Realtek RTL 8111E/8111F</p> <p>10 / 100 / 1000 Mb/s Auto-Negotiation</p> <p>Halb-/ Vollduplex-Funktion</p>	<p>Realtek RTL 8111E/8111F</p> <p>10 / 100 / 1000 Mb/s Auto-Negotiation</p> <p>Halb-/ Vollduplex-Funktion</p>
HD Audio-Unterstützung	<p>VT1708B/ALC662</p> <p>5.1-Kanal-Audioausgabe</p> <p>Unterstützt High-Definition Audio</p>	<p>VT1708B/ALC662</p> <p>5.1-Kanal-Audioausgabe</p> <p>Unterstützt High-Definition Audio</p>
USB3.0	A75	N/A
Steckplätze	<p>PCI Express Gen2 x16 Steckplatz x1</p> <p>PCI Express Gen2 x1 Steckplatz x2</p> <p>PCI-Steckplatz x1</p>	<p>PCI Express Gen2 x16 Steckplatz x1</p> <p>PCI Express Gen2 x1 Steckplatz x2</p> <p>PCI-Steckplatz x1</p>

A75MH / A55MH

	A75MH		A55MH	
Onboard-Anschluss	SATA3-Anschluss	x6	SATA2-Anschluss	x6
	Fronttafelanschluss	x1	Fronttafelanschluss	x1
	Front-Audioanschluss	x1	Front-Audioanschluss	x1
	S/PDIF- Ausgangsanschluss	x1	S/PDIF- Ausgangsanschluss	x1
	CPU-Lüfter-Sockel	x1	CPU-Lüfter-Sockel	x1
	System-Lüfter-Sockel	x1	System-Lüfter-Sockel	x1
	"CMOS löschen"-Sockel	x1	"CMOS löschen"-Sockel	x1
	USB 2.0-Anschluss	x2	USB 2.0-Anschluss	x2
	USB 3.0-Anschluss	x1	N/A	
	Stromanschluss (24-polig)	x1	Stromanschluss (24-polig)	x1
	Stromanschluss (4-polig)	x1	Stromanschluss (4-polig)	x1
	Verbraucher-IR Anschluss	x1	Verbraucher-IR Anschluss	x1
	Druckeranschluss Anschluss	x1	Druckeranschluss Anschluss	x1
Serieller Anschluss	x1	Serieller Anschluss	x1	
Rückseiten-E/A	PS/2-Tastatur / Maus	x1	PS/2-Tastatur / Maus	x1
	HDMI-Anschluss	x1	HDMI-Anschluss	x1
	VGA-Anschluss	x1	VGA-Anschluss	x1
	DVI-D-Anschluss	x1	DVI-D-Anschluss	x1
	LAN-Anschluss	x1	LAN-Anschluss	x1
	USB 2.0-Anschluss	x2	USB 2.0-Anschluss	x4
	USB 3.0-Anschluss	x2	Audioanschluss	x3
Audioanschluss	x3			
Platinengröße	200 mm (B) X 244 mm (L)		200 mm (B) X 244 mm (L)	
Sonderfunktionen	Unterstützt RAID 0 / 1 / 10		Unterstützt RAID 0 / 1 / 10	
OS-Unterstützung	Windows XP / Vista / 7 Biostar behält sich das Recht vor, ohne Ankündigung die Unterstützung für ein Betriebssystem hinzuzufügen oder zu entfernen.		Windows XP / Vista / 7 Biostar behält sich das Recht vor, ohne Ankündigung die Unterstützung für ein Betriebssystem hinzuzufügen oder zu entfernen.	

FRENCH

	A75MH	A55MH
UC	Socket FM1 Processeurs AMD A-Series / E2-Series L'architecture AMD 64 permet le calcul 32 et 64 bits	Socket FM1 Processeurs AMD A-Series / E2-Series L'architecture AMD 64 permet le calcul 32 et 64 bits
Chipset	AMD A75	AMD A55
Super E/S	ITE 8728 Fournit la fonctionnalité de Super E/S patrimoniales la plus utilisée. Interface à faible compte de broches Initiatives de contrôle environnementales Moniteur de matériel Fonction "Gardien intelligent" de l'ITE	ITE 8728 Fournit la fonctionnalité de Super E/S patrimoniales la plus utilisée. Interface à faible compte de broches Initiatives de contrôle environnementales Moniteur de matériel Fonction "Gardien intelligent" de l'ITE
Mémoire principale	Fentes DDR3 DIMM x 2 Capacité mémoire maximale de 16Go Chaque DIMM prend en charge des DDR3 de 256 Mo/512 Mo et 1Go/2Go/4Go/8Go Module de mémoire DDR3 à mode à double voie Prend en charge la DDR3 800/1066/1333/1600/1866 Les DIMM à registres et DIMM avec code correcteurs d'erreurs ne sont pas prises en charge	Fentes DDR3 DIMM x 2 Capacité mémoire maximale de 16Go Chaque DIMM prend en charge des DDR3 de 256 Mo/512 Mo et 1Go/2Go/4Go/8Go Module de mémoire DDR3 à mode à double voie Prend en charge la DDR3 800/1066/1333/1600/1866 Les DIMM à registres et DIMM avec code correcteurs d'erreurs ne sont pas prises en charge
SATA3/ SATA2	Contrôleur Serial ATA intégré Taux de transfert jusqu'à 6 Go/s Conforme à la spécification SATA Version 3.0	Contrôleur Serial ATA intégré Taux de transfert jusqu'à 3 Go/s Conforme à la spécification SATA Version 2.0
LAN	Realtek RTL 8111E/8111F 10 / 100 / 1000 Mb/s négociation automatique Half / Full duplex capability	Realtek RTL 8111E/8111F 10 / 100 / 1000 Mb/s négociation automatique Half / Full duplex capability
Prise en charge audio HD	VT1708B/ALC662 Sortie audio à 5.1 voies Prise en charge de l'audio haute définition	VT1708B/ALC662 Sortie audio à 5.1 voies Prise en charge de l'audio haute définition
USB3.0	A75	N/A
Fentes	Fente PCI Express Gen2 x16 x1 Fente PCI Express Gen2 x1 x2 Fente PCI x1	Fente PCI Express Gen2 x16 x1 Fente PCI Express Gen2 x1 x2 Fente PCI x1

A75MH / A55MH

	A75MH	A55MH
Connecteur embarqué	Connecteur SATA3 x6	Connecteur SATA2 x6
	Connecteur du panneau avant x1	Connecteur du panneau avant x1
	Connecteur Audio du panneau avant x1	Connecteur Audio du panneau avant x1
	Connecteur de sortie S/PDIF x1	Connecteur de sortie S/PDIF x1
	Embase de ventilateur UC x1	Embase de ventilateur UC x1
	Embase de ventilateur système x1	Embase de ventilateur système x1
	Embase d'effacement CMOS x1	Embase d'effacement CMOS x1
	Connecteur USB 2.0 x2	Connecteur USB 2.0 x2
	Connecteur USB 3.0 x1	N/A
	Connecteur d'alimentation (24 broches) x1	Connecteur d'alimentation (24 broches) x1
	Connecteur d'alimentation (4 broches) x1	Connecteur d'alimentation (4 broches) x1
	Connecteur de IR du consommateur x1	Connecteur de IR du consommateur x1
	Connecteur de Port d'imprimante x1	Connecteur de Port d'imprimante x1
Connecteur de Port série x1	Connecteur de Port série x1	
E/S du panneau arrière	Clavier / Souris PS/2 x1	Clavier / Souris PS/2 x1
	Port HDMI x1	Port HDMI x1
	Port VGA x1	Port VGA x1
	Port DVI-D x1	Port DVI-D x1
	Port LAN x1	Port LAN x1
	Port USB 2.0 x2	Port USB 2.0 x1
	Port USB 3.0 x2	Port USB 2.0 x4
	Fiche audio x3	Fiche audio x3
Dimensions de la carte	200 mm (l) X 244 mm (H)	200 mm (l) X 244 mm (H)
Fonctionnalités spéciales	Prise en charge RAID 0 / 1 / 10	Prise en charge RAID 0 / 1 / 10
Support SE	Windows XP / Vista / 7 Biostar se réserve le droit d'ajouter ou de supprimer le support de SE avec ou sans préavis.	Windows XP / Vista / 7 Biostar se réserve le droit d'ajouter ou de supprimer le support de SE avec ou sans préavis.

ITALIAN

	A75MH	A55MH
CPU	Socket FM1 Processori AMD A-Series / E2-Series L'architettura AMD 64 abilita la computazione 32 e 64 bit	Socket FM1 Processori AMD A-Series / E2-Series L'architettura AMD 64 abilita la computazione 32 e 64 bit
Chipset	AMD A75	AMD A55
Super I/O	ITE 8728 Fornisce le funzionalità legacy Super I/O usate più comunemente. Interfaccia LPC (Low Pin Count) Funzioni di controllo dell'ambiente: Monitoraggio hardware Funzione "Smart Guardian" di ITE	ITE 8728 Fornisce le funzionalità legacy Super I/O usate più comunemente. Interfaccia LPC (Low Pin Count) Funzioni di controllo dell'ambiente: Monitoraggio hardware Funzione "Smart Guardian" di ITE
Memoria principale	Alloggi DIMM DDR3 x 2 Capacità massima della memoria 16GB Ciascun DIMM supporta DDR3 512MB e 1GB/2GB/4GB/8GB Modulo di memoria DDR3 a canale doppio Supporto di DDR3 800/1066/1333/1600/1866 DIMM registrati e DIMM ECC non sono supportati	Alloggi DIMM DDR3 x 2 Capacità massima della memoria 16GB Ciascun DIMM supporta DDR3 512MB e 1GB/2GB/4GB/8GB Modulo di memoria DDR3 a canale doppio Supporto di DDR3 800/1066/1333/1600/1866 DIMM registrati e DIMM ECC non sono supportati
SATA3/ SATA2	Controller Serial ATA integrato Velocità di trasferimento dei dati fino a 6 Gb/s Compatibile specifiche SATA Versione 3.0	Controller Serial ATA integrato Velocità di trasferimento dei dati fino a 3 Gb/s Compatibile specifiche SATA Versione 2.0
LAN	Realtek RTL 8111E/8111F Negoziazione automatica 10 / 100 / 1000 Mb/s Capacità Half / Full Duplex	Realtek RTL 8111E/8111F Negoziazione automatica 10 / 100 / 1000 Mb/s Capacità Half / Full Duplex
Supporto audio HD	VT1708B/ALC662 Uscita audio 5.1 canali Supporto audio High-Definition (HD)	VT1708B/ALC662 Uscita audio 5.1 canali Supporto audio High-Definition (HD)
USB3.0	A75	N/A
Alloggi	Alloggio PCI Express Gen2 x16 x1 Alloggio PCI Express Gen2 x1 x2 Alloggio PCI x1	Alloggio PCI Express Gen2 x16 x1 Alloggio PCI Express Gen2 x1 x2 Alloggio PCI x1

A75MH / A55MH

	A75MH	A55MH
Connettori su scheda	Connettore SATA3 x6	Connettore SATA2 x6
	Connettore pannello frontale x1	Connettore pannello frontale x1
	Connettore audio frontale x1	Connettore audio frontale x1
	Connettore output SPDIF x1	Connettore output SPDIF x1
	Collettore ventolina CPU x1	Collettore ventolina CPU x1
	Collettore ventolina sistema x1	Collettore ventolina sistema x1
	Collettore cancellazione CMOS x1	Collettore cancellazione CMOS x1
	Connettore USB 2.0 x2	Connettore USB 2.0 x2
	Connettore USB 3.0 x1	N/A
	Connettore alimentazione (24 pin) x1	Connettore alimentazione (24 pin) x1
	Connettore alimentazione (4 pin) x1	Connettore alimentazione (4 pin) x1
	Connettore IR del consumatore x1	Connettore IR del consumatore x1
Connettore Porta stampante x1	Connettore Porta stampante x1	
Connettore Porta seriale x1	Connettore Porta seriale x1	
I/O pannello posteriore	Tastiera / Mouse PS/2 x1	Tastiera / Mouse PS/2 x1
	Porta HDMI x1	Porta HDMI x1
	Porta VGA x1	Porta VGA x1
	Porta DVI-D x1	Porta DVI-D x1
	Porta LAN x1	Porta LAN x1
	Porta USB 2.0 x2	Porta USB 2.0 x4
	Porta USB 3.0 x2	Connettore audio x3
Dimensioni scheda	200 mm (larghezza) x 244 mm (altezza)	200 mm (larghezza) x 244 mm (altezza)
Caratteristiche speciali	Supporto RAID 0 / 1 / 10	Supporto RAID 0 / 1 / 10
Sistemi operativi supportati	Windows XP / Vista / 7 Biostar si riserva il diritto di aggiungere o rimuovere il supporto di qualsiasi sistema operativo senza preavviso.	Windows XP / Vista / 7 Biostar si riserva il diritto di aggiungere o rimuovere il supporto di qualsiasi sistema operativo senza preavviso.

SPANISH

	A75MH	A55MH
CPU	<p>Conector FM1</p> <p>Procesadores AMD A-Series / E2-Series</p> <p>La arquitectura AMD 64 permite el procesado de 32 y 64 bits</p>	<p>Conector FM1</p> <p>Procesadores AMD A-Series / E2-Series</p> <p>La arquitectura AMD 64 permite el procesado de 32 y 64 bits</p>
Conjunto de chips	AMD A75	AMD A55
Súper E/S	<p>ITE 8728</p> <p>Le ofrece las funcionalidades heredadas de uso más común Súper E/S.</p> <p>Interfaz de cuenta Low Pin</p> <p>Iniciativas de control de entorno, Monitor hardware</p> <p>Función "Guardia inteligente" de ITE</p>	<p>ITE 8728</p> <p>Le ofrece las funcionalidades heredadas de uso más común Súper E/S.</p> <p>Interfaz de cuenta Low Pin</p> <p>Iniciativas de control de entorno, Monitor hardware</p> <p>Función "Guardia inteligente" de ITE</p>
Memoria principal	<p>Ranuras DIMM DDR3 x 2</p> <p>Capacidad máxima de memoria de 16GB</p> <p>Cada DIMM admite DDR de 512MB y 1GB/2GB/4GB/8GB</p> <p>Módulo de memoria DDR3 de canal Doble</p> <p>Admite DDR3 de 800/1066/1333/1600/1866</p> <p>No admite DIMM registrados o DIMM compatibles con ECC</p>	<p>Ranuras DIMM DDR3 x 2</p> <p>Capacidad máxima de memoria de 16GB</p> <p>Cada DIMM admite DDR de 512MB y 1GB/2GB/4GB/8GB</p> <p>Módulo de memoria DDR3 de canal Doble</p> <p>Admite DDR3 de 800/1066/1333/1600/1866</p> <p>No admite DIMM registrados o DIMM compatibles con ECC</p>
SATA3/ SATA2	<p>Controlador ATA Serie Integrado</p> <p>Tasas de transferencia de hasta 6 Gb/s</p> <p>Compatible con la versión SATA 3.0</p>	<p>Controlador ATA Serie Integrado</p> <p>Tasas de transferencia de hasta 3 Gb/s</p> <p>Compatible con la versión SATA 2.0</p>
Red Local	<p>Realtek RTL 8111E/8111F</p> <p>Negociación de 10 / 100 / 1000 Mb/s</p> <p>Funciones Half / Full dúplex</p>	<p>Realtek RTL 8111E/8111F</p> <p>Negociación de 10 / 100 / 1000 Mb/s</p> <p>Funciones Half / Full dúplex</p>
Soporte de sonido HD	<p>VT1708B/ALC662</p> <p>Salida de sonido de 5.1 canales</p> <p>Soporte de sonido Alta Definición</p>	<p>VT1708B/ALC662</p> <p>Salida de sonido de 5.1 canales</p> <p>Soporte de sonido Alta Definición</p>
USB3.0	A75	N/A
Ranuras	<p>Ranura PCI Express Gen2 x16 X1</p> <p>Ranura PCI Express Gen2 x1 X2</p> <p>Ranura PCI X1</p>	<p>Ranura PCI Express Gen2 x16 X1</p> <p>Ranura PCI Express Gen2 x1 X2</p> <p>Ranura PCI X1</p>

A75MH / A55MH

		A75MH	A55MH
Conectores en placa	Conector SATA3	X6	Conector SATA2 X6
	Conector de panel frontal	X1	Conector de panel frontal X1
	Conector de sonido frontal	X1	Conector de sonido frontal X1
	Conector de salida S/PDIF	X1	Conector de salida S/PDIF X1
	Cabecera de ventilador de CPU	X1	Cabecera de ventilador de CPU X1
	Cabecera de ventilador de sistema	X1	Cabecera de ventilador de sistema X1
	Cabecera de borrado de CMOS	X1	Cabecera de borrado de CMOS X1
	Conector USB 2.0	X2	Conector USB 2.0 X2
	Conector USB 3.0	X1	N/A
	Conector de alimentación (24 patillas)	X1	Conector de alimentación (24 patillas) X1
	Conector de alimentación (4 patillas)	X1	Conector de alimentación (4 patillas) X1
	Conector de IR del consumidor	X1	Conector de IR del consumidor X1
Conector Puerto de impresora	X1	Conector Puerto de impresora X1	
Conector Puerto serie	X1	Conector Puerto serie X1	
Panel trasero de E/S	Teclado / Ratón PS/2	X1	Teclado / Ratón PS/2 X1
	Ratón HDMI	X1	Ratón HDMI X1
	Puerto VGA	X1	Puerto VGA X1
	Puerto DVI-D	X1	Puerto DVI-D X1
	Puerto de red local	X1	Puerto de red local X1
	Puerto USB 2.0	X2	Puerto USB 2.0 X4
	Puerto USB 3.0	X2	Conector de sonido X3
	Conector de sonido	X3	
Tamaño de la placa	200 mm. (A) X 244 Mm. (H)	200 mm. (A) X 244 Mm. (H)	
Funciones especiales	Admite RAID 0 / 1 / 10	Admite RAID 0 / 1 / 10	
Soporte de sistema operativo	Windows XP / Vista / 7 Biostar se reserva el derecho de añadir o retirar el soporte de cualquier SO con o sin aviso previo.	Windows XP / Vista / 7 Biostar se reserva el derecho de añadir o retirar el soporte de cualquier SO con o sin aviso previo.	

PORTUGUESE

	A75MH	A55MH
CPU	Socket FM1 Processadores AMD A-Series / E2-Series A arquitectura AMD 64 permite uma computação de 32 e 64 bits	Socket FM1 Processadores AMD A-Series / E2-Series A arquitectura AMD 64 permite uma computação de 32 e 64 bits
Chipset	AMD A75	AMD A55
Especificação Super I/O	ITE 8728 Proporciona as funcionalidades mais utilizadas em termos da especificação Super I/O. Interface LPC (Low Pin Count). Iniciativas para controlo do ambiente Monitorização do hardware Função "Smart Guardian" da ITE	ITE 8728 Proporciona as funcionalidades mais utilizadas em termos da especificação Super I/O. Interface LPC (Low Pin Count). Iniciativas para controlo do ambiente Monitorização do hardware Função "Smart Guardian" da ITE
Memória principal	Ranhuras DIMM DDR3 x 2 Capacidade máxima de memória: 16GB Cada módulo DIMM suporta uma memória DDR3 de 512 MB & 1GB/2GB/4GB/8GB Módulo de memória DDR3 de canal duplo Suporta módulos DDR3 800/1066/1333/1600/1866 Os módulos DIMM registados e os DIMM ECC não são suportados	Ranhuras DIMM DDR3 x 2 Capacidade máxima de memória: 16GB Cada módulo DIMM suporta uma memória DDR3 de 512 MB & 1GB/2GB/4GB/8GB Módulo de memória DDR3 de canal duplo Suporta módulos DDR3 800/1066/1333/1600/1866 Os módulos DIMM registados e os DIMM ECC não são suportados
SATA3/ SATA2	Controlador Serial ATA integrado Velocidades de transmissão de dados até 6 Gb/s Compatibilidade com a especificação SATA versão 3.0	Controlador Serial ATA integrado Velocidades de transmissão de dados até 3 Gb/s Compatibilidade com a especificação SATA versão 2.0
LAN	Realtek RTL 8111E/8111F Auto negociação de 10 / 100 / 1000 Mb/s Capacidade semi/full-duplex	Realtek RTL 8111E/8111F Auto negociação de 10 / 100 / 1000 Mb/s Capacidade semi/full-duplex
Suporte para áudio de alta definição	VT1708B/ALC662 Saída de áudio de 5.1 canais Suporta a especificação High-Definition Audio	VT1708B/ALC662 Saída de áudio de 5.1 canais Suporta a especificação High-Definition Audio
USB3.0	A75	N/A
Ranhuras	Ranhura PCI Express Gen2 x16 x1 Ranhura PCI Express Gen2 x1 x2 Ranhura PCI x1	Ranhura PCI Express Gen2 x16 x1 Ranhura PCI Express Gen2 x1 x2 Ranhura PCI x1

A75MH / A55MH

	A75MH	A55MH		
Conectores na placa	Conector SATA3	x6	Conector SATA2	x6
	Conector do painel frontal	x1	Conector do painel frontal	x1
	Conector de áudio frontal	x1	Conector de áudio frontal	x1
	Conector de saída S/PDIF	x1	Conector de saída S/PDIF	x1
	Conector da ventoinha da CPU	x1	Conector da ventoinha da CPU	x1
	Conector da ventoinha do sistema	x1	Conector da ventoinha do sistema	x1
	Conector para limpeza do CMOS	x1	Conector para limpeza do CMOS	x1
	Conector USB 2.0	x2	Conector USB 2.0	x2
	Conector USB 3.0	x1	N/A	
	Conector de alimentação (24 pinos)	x1	Conector de alimentação (24 pinos)	x1
	Conector de alimentação (4 pinos)	x1	Conector de alimentação (4 pinos)	x1
	Conector de IR do consumidor	x1	Conector de IR do consumidor	x1
	Conector da para impressora	x1	Conector da para impressora	x1
Conector da Porta série	x1	Conector da Porta série	x1	
Entradas/Saídas no painel traseiro	Teclado / Rato PS/2	x1	Teclado / Rato PS/2	x1
	Porta HDMI	x1	Porta HDMI	x1
	Porta VGA	x1	Porta VGA	x1
	Porta DVI-D	x1	Porta DVI-D	x1
	Porta LAN	x1	Porta LAN	x1
	Porta USB 2.0	x2	Porta USB 2.0	x4
	Porta USB 3.0	x2	Tomada de áudio	x3
	Tomada de áudio	x3		
Tamanho da placa	200 mm (L) X 244 mm (A)	200 mm (L) X 244 mm (A)		
Características especiais	Suporta as funções RAID 0 / 1 / 10	Suporta as funções RAID 0 / 1 / 10		
Sistemas operativos suportados	Windows XP / Vista / 7 A Biostar reserva-se o direito de adicionar ou remover suporte para qualquer sistema operativo com ou sem aviso prévio.	Windows XP / Vista / 7 A Biostar reserva-se o direito de adicionar ou remover suporte para qualquer sistema operativo com ou sem aviso prévio.		

POLISH

	A75MH	A55MH
Procesor	Socket FM1 AMD A-Series / E2-Series Procesory Architektura AMD 64 umożliwia przetwarzanie 32 i 64 bitowe	Socket FM1 AMD A-Series / E2-Series Procesory Architektura AMD 64 umożliwia przetwarzanie 32 i 64 bitowe
Chipset	AMD A75	AMD A55
Pamięć główna	Gniazda DDR3 DIMM x 2 Maks. wielkość pamięci 16GB Każde gniazdo DIMM obsługuje moduły 512MB oraz 1GB/2GB/4GB/8GB DDR3 Moduł pamięci DDR3 z trybem podwójnego kanału Obsługa DDR3 800/1066/1333/1600/1866 Brak obsługi Registered DIMM oraz ECC DIMM	Gniazda DDR3 DIMM x 2 Maks. wielkość pamięci 16GB Każde gniazdo DIMM obsługuje moduły 512MB oraz 1GB/2GB/4GB/8GB DDR3 Moduł pamięci DDR3 z trybem podwójnego kanału Obsługa DDR3 800/1066/1333/1600/1866 Brak obsługi Registered DIMM oraz ECC DIMM
Super I/O	ITE 8728 Zapewnia najbardziej powszechne funkcje Super I/O. Interfejs Low Pin Count Funkcje kontroli warunków pracy Monitor H/W Funkcja ITE "Smart Guardian"	ITE 8728 Zapewnia najbardziej powszechne funkcje Super I/O. Interfejs Low Pin Count Funkcje kontroli warunków pracy Monitor H/W Funkcja ITE "Smart Guardian"
SATA3/ SATA2	Zintegrowany kontroler Serial ATA Transfer danych do 6 Gb/s Zgodność ze specyfikacją SATA w wersji 3.0	Zintegrowany kontroler Serial ATA Transfer danych do 3 Gb/s Zgodność ze specyfikacją SATA w wersji 2.0
LAN	Realtek RTL 8111E/8111F 110 / 100 / 1000 Mb/s z automatyczną negocjacją szybkości Działanie w trybie połowicznego / pełnego duplexu	Realtek RTL 8111E/8111F 110 / 100 / 1000 Mb/s z automatyczną negocjacją szybkości Działanie w trybie połowicznego / pełnego duplexu
Obsługa audio HD	VT1708B/ALC662 5.1 kanałowe wyjście audio Obsługa High-Definition Audio	VT1708B/ALC662 5.1 kanałowe wyjście audio Obsługa High-Definition Audio
USB3.0	A75	N/A
Gniazda	Gniazdo PCI Express Gen2 x16 x1 Gniazdo PCI Express Gen2 x1 x2 Gniazdo PCI x1	Gniazdo PCI Express Gen2 x16 x1 Gniazdo PCI Express Gen2 x1 x2 Gniazdo PCI x1

A75MH / A55MH

	A75MH	A55MH		
Złącza wbudowane	Złącze SATA3	x6	Złącze SATA2	x6
	Złącze panela przedniego	x1	Złącze panela przedniego	x1
	Przednie złącze audio	x1	Przednie złącze audio	x1
	Złącze wyjścia S/PDIF	x1	Złącze wyjścia S/PDIF	x1
	Złącze główkowe wentylatora procesora	x1	Złącze główkowe wentylatora procesora	x1
	Złącze główkowe wentylatora systemowego	x1	Złącze główkowe wentylatora systemowego	x1
	Złącze główkowe kasowania CMOS	x1	Złącze główkowe kasowania CMOS	x1
	Złącze USB 2.0	x2	Złącze USB 2.0	x2
	Złącze USB 3.0	x1	N/A	
	Złącze zasilania (24 pinowe)	x1	Złącze zasilania (24 pinowe)	x1
	Złącze zasilania (4 pinowe)	x1	Złącze zasilania (4 pinowe)	x1
	Złącze Konsument IR	x1	Złącze Konsument IR	x1
	Złącze Port drukarki	x1	Złącze Port drukarki	x1
Złącze Port szeregowy	x1	Złącze Port szeregowy	x1	
Back Panel I/O	Klawiatura / Mysz PS/2	x1	Klawiatura / Mysz PS/2	x1
	Port HDMI	x1	Port HDMI	x1
	Port VGA	x1	Port VGA	x1
	Port DVI-D	x1	Port DVI-D	x1
	Port LAN	x1	Port LAN	x1
	Port USB 2.0	x2	Port USB 2.0	x4
	Port USB 3.0	x2		
	Gniazdo audio	x3	Gniazdo audio	x3
Wymiary płyty	200 mm (S) X 244 mm (W)		200 mm (S) X 244 mm (W)	
Funkcje specjalne	Obsługa RAID 0 / 1 / 10		Obsługa RAID 0 / 1 / 10	
Obsługa systemu operacyjnego	Windows XP / Vista / 7 Biostar zastrzega sobie prawo dodawania lub odwoływania obsługi dowolnego systemu operacyjnego bez powiadomienia.		Windows XP / Vista / 7 Biostar zastrzega sobie prawo dodawania lub odwoływania obsługi dowolnego systemu operacyjnego bez powiadomienia.	

RUSSIAN

	A75MH	A55MH
CPU (центральный процессор)	Гнездо FM1 Процессоры AMD A-Series / E2-Series Архитектура AMD 64 разрешать обработка данных на 32 и 64 бит	Гнездо FM1 Процессоры AMD A-Series / E2-Series Архитектура AMD 64 разрешать обработка данных на 32 и 64 бит
Набор микросхем	AMD A75	AMD A55
Основная память	Слоты DDR3 DIMM x 2 Максимальная ёмкость памяти 16ГБ Каждый модуль DIMM поддерживает 512МБ & 1ГБ/2ГБ/4ГБ/8ГБ DDR3 Модуль памяти с двухканальным режимом DDR3 Поддержка DDR3 800/1066/1333/1600/1866 Не поддерживает зарегистрированные модули DIMM and ECC DIMM	Слоты DDR3 DIMM x 2 Максимальная ёмкость памяти 16ГБ Каждый модуль DIMM поддерживает 512МБ & 1ГБ/2ГБ/4ГБ/8ГБ DDR3 Модуль памяти с двухканальным режимом DDR3 Поддержка DDR3 800/1066/1333/1600/1866 Не поддерживает зарегистрированные модули DIMM and ECC DIMM
Super I/O	ITE 8728 Обеспечивает наиболее используемые действующие функциональные возможности Super I/O. Интерфейс с низким количеством выводов Инициативы по охране окружающей среды, Аппаратный монитор Функция ITE "Smart Guardian" (Интеллектуальная защита)	ITE 8728 Обеспечивает наиболее используемые действующие функциональные возможности Super I/O. Интерфейс с низким количеством выводов Инициативы по охране окружающей среды, Аппаратный монитор Функция ITE "Smart Guardian" (Интеллектуальная защита)
SATA3/ SATA2	Встроенное последовательное устройство управления ATA скорость передачи данных до 6 гигабит/с. Соответствие спецификации SATA версия 3.0	Встроенное последовательное устройство управления ATA скорость передачи данных до 3 гигабит/с. Соответствие спецификации SATA версия 2.0
Локальная сеть	Realtek RTL 8111E/8111F Автоматическое согласование 10 / 100 / 1000 Мб/с Частичная / полная дуплексная способность	Realtek RTL 8111E/8111F Автоматическое согласование 10 / 100 / 1000 Мб/с Частичная / полная дуплексная способность
Звуковая поддержка жесткого диска	VT1708B/ALC662 Звуковая поддержка High-Definition 5.1канальный звуковой выход	VT1708B/ALC662 Звуковая поддержка High-Definition 5.1канальный звуковой выход
USB3.0	A75	N/A
Слоты	Слот PCI Express Gen2 x16 x1 Слот PCI Express Gen2 x1 x2 Слот PCI x1	Слот PCI Express Gen2 x16 x1 Слот PCI Express Gen2 x1 x2 Слот PCI x1

A75MH / A55MH

	A75MH	A55MH		
Встроенный разъем	Разъем SATA3	x6	Разъем SATA2	x6
	Разъем на лицевой панели	x1	Разъем на лицевой панели	x1
	Входной звуковой разъем	x1	Входной звуковой разъем	x1
	Разъем вывода для S/PDIF	x1	Разъем вывода для S/PDIF	x1
	Контактирующее приспособление вентилятора центрального процессора	x1	Контактирующее приспособление вентилятора центрального процессора	x1
	Контактирующее приспособление вентилятора системы	x1	Контактирующее приспособление вентилятора системы	x1
	Открытое контактирующее приспособление CMOS	x1	Открытое контактирующее приспособление CMOS	x1
	USB 2.0-разъем	x2	USB 2.0-разъем	x2
	USB 3.0-разъем	x1	N/A	
	Разъем питания (24 вывод)	x1	Разъем питания (24 вывод)	x1
	Разъем питания (4 вывод)	x1	Разъем питания (4 вывод)	x1
	Разъем едока ИКБЫЙ	x1	Разъем едока ИКБЫЙ	x1
	Разъем Порт подключения принтера	x1	Разъем Порт подключения принтера	x1
	Разъем Последовательный порт	x1	Разъем Последовательный порт	x1
Задняя панель средств ввода-вывода	Клавиатура / Мышь PS/2	x1	Клавиатура / Мышь PS/2	x1
	Порт HDMI	x1	Порт HDMI	x1
	Порт VGA	x1	Порт VGA	x1
	Порт DVI-D	x1	Порт DVI-D	x1
	Порт LAN	x1	Порт LAN	x1
	USB 2.0-порт	x2	USB 2.0-порт	x4
	USB 3.0-порт	x2		
	Гнездо для подключения наушников	x3	Гнездо для подключения наушников	x3
Размер панели	200 мм (Ш) X 244 мм (В)	200 мм (Ш) X 244 мм (В)		
Специальные технические характеристики	Поддержка RAID 0 / 1 / 10	Поддержка RAID 0 / 1 / 10		
Поддержка OS	Windows XP / Vista / 7 Biostar сохраняет за собой право добавлять или удалять средства обеспечения для OS или без предварительного уведомления.	Windows XP / Vista / 7 Biostar сохраняет за собой право добавлять или удалять средства обеспечения для OS или без предварительного уведомления.		

ARABIC

A55MH		A75MH		
FM1 مقبس A مقبس	AMD A-Series / E2-Series معالجات	FM1 مقبس	AMD A-Series / E2-Series معالجات	وحدة المعالجة المركزية
إجراء العمليات الحاسوبية بسرعة 32 و 64 بت AMD 64 يمكن تقنية		إجراء العمليات الحاسوبية بسرعة 32 و 64 بت AMD 64 يمكن تقنية		
AMD A55		AMD A75		مجموعة الشرائح
ITE 8728	الأكثر استخداماً. Super I/O يوفر وظيفة Low Pin Count Interface تدعم تقنية وسائل التحكم في البيئة: مراقب لمعرفة حالة الأجهزة	ITE 8728	الأكثر استخداماً. Super I/O يوفر وظيفة Low Pin Count Interface تدعم تقنية وسائل التحكم في البيئة: مراقب لمعرفة حالة الأجهزة	Super I/O
قناة DDR3 DIMM عدد 2	سعة ذاكرة قصوى 16 جيجا بايت	قناة DDR3 DIMM عدد 2	سعة ذاكرة قصوى 16 جيجا بايت	الذاكرة الرئيسية
ميجا بايت 5/12 سعة DDR3 تدعم ذاكرة من نوع DIMM كل فتحة و 1/2 و 4/8 جيجا بايت	مزدوجة القناة DDR3 وحدة ذاكرة سعة DDR3 تدعم ذاكرة من نوع ECC وتلك التي لا تتوافق مع DIMM لا تدعم رقائق الذاكرة	ميجا بايت 5/12 سعة DDR3 تدعم ذاكرة من نوع DIMM كل فتحة و 1/2 و 4/8 جيجا بايت	مزدوجة القناة DDR3 وحدة ذاكرة سعة DDR3 تدعم ذاكرة من نوع ECC وتلك التي لا تتوافق مع DIMM لا تدعم رقائق الذاكرة	
متكامل Serial ATA -متك	جيجابت/ثانية، 3 نقل البيانات بسرعة تصل إلى SATA 2.0 الإصدار مطابقة لمواصفات	متكامل Serial ATA -متك	جيجابت/ثانية، 6 نقل البيانات بسرعة تصل إلى SATA 3.0 الإصدار مطابقة لمواصفات	SATA3/ SATA2
Realtek RTL 8111E/8111F	تفاوض تلقائي 100/10 ميجا بايت / ثانية و 1 جيجا بايت/ثانية إمكانية النقل المزدوج الكامل/القصفي	Realtek RTL 8111E/8111F	تفاوض تلقائي 100/10 ميجا بايت / ثانية و 1 جيجا بايت/ثانية إمكانية النقل المزدوج الكامل/القصفي	شبكة داخلية
VT1708B/ALC662	قوات لخرج الصوت 5.1 تدعم تقنية الصوت عالي التعريف من	VT1708B/ALC662	قوات لخرج الصوت 5.1 تدعم تقنية الصوت عالي التعريف من	دعم الصوت عالي التعريف
N/A		A75		USB3.0
عدد 1 فتحة PCI Express Gen2 x16	عدد 2 فتحة PCI Express Gen2 x1	عدد 1 فتحة PCI Express Gen2 x16	عدد 2 فتحة PCI Express Gen2 x1	الفتحات
عدد 1 فتحة PCI		عدد 1 فتحة PCI		

A75MH / A55MH

A55MH		A75MH		
عدد 6	منفذ SATA2	عدد 6	منفذ SATA3	المنافذ على سطح اللوحة
عدد 1	منفذ للوحة الأممية	عدد 1	منفذ للوحة الأممية	
عدد 1	منفذ الصوت الأممي	عدد 1	منفذ الصوت الأممي	
عدد 1	منفذ خرج S/PDIF	عدد 1	منفذ خرج S/PDIF	
عدد 1	وصلة مروحة وحدة المعالجة المركزية	عدد 1	وصلة مروحة وحدة المعالجة المركزية	
عدد 1	وصلة مروحة النظام	عدد 1	وصلة مروحة النظام	
عدد 1	وصلة مسح CMOS	عدد 1	وصلة مسح CMOS	
عدد 2	منفذ USB 2.0	عدد 2	منفذ USB 2.0	
	N/A	عدد 1	منفذ USB 3.0	
عدد 1	منفذ توصيل الطاقة (24بيوس)	عدد 1	منفذ توصيل الطاقة (24بيوس)	
عدد 1	منفذ توصيل الطاقة (4بيوس)	عدد 1	منفذ توصيل الطاقة (4بيوس)	
عدد 1	منفذ الأحمر تحت مستهلكة	عدد 1	منفذ الأحمر تحت مستهلكة	
عدد 1	منفذ طباعة	عدد 1	منفذ طباعة	
عدد 1	منفذ تسلسلي	عدد 1	منفذ تسلسلي	
عدد 1	لوحة مفاتيح / ملوس PS/2	عدد 1	لوحة مفاتيح / ملوس PS/2	منفذ دخل/خرج اللوحة الخلفية
عدد 1	منافذ HDMI	عدد 1	منافذ HDMI	
عدد 1	منافذ VGA	عدد 1	منافذ VGA	
عدد 1	منافذ DVI-D	عدد 1	منافذ DVI-D	
عدد 1	منفذ شبكة اتصال محلية	عدد 1	منفذ شبكة اتصال محلية	
عدد 4	منافذ 2.0USB	عدد 2	منافذ USB2.0 (قبل من SB850)	
عدد 3	مقيس صوت	عدد 2	منافذ USB3.0 (قبل من A75)	
		عدد 3	مقيس صوت	
200مم (عرض) X 244 مم (ارتفاع)		200مم (عرض) X 244 مم (ارتفاع)		حجم اللوحة
RAID 0 / 1 / 10 دعم تقنية		RAID 0 / 1 / 10 دعم تقنية		مزايا خاصة
Windows XP / Vista / 7 بحقها في اضافة أو ازالة الدعم لأي نظام تشغيل بإخطار أو Biostar تحتفظ بدون إخطار .		Windows XP / Vista / 7 بحقها في اضافة أو ازالة الدعم لأي نظام تشغيل بإخطار أو Biostar تحتفظ بدون إخطار .		دعم أنظمة التشغيل

JAPANESE

	A75MH	A55MH
CPU	Socket FM1 AMD A-Series / E2-Series プロセッサ AMD 64アーキテクチャでは、32ビットと64ビット計算が可能です	Socket FM1 AMD A-Series / E2-Series プロセッサ AMD 64アーキテクチャでは、32ビットと64ビット計算が可能です
チップセット	AMD A75	AMD A55
メインメモリ	DDR3 DIMMスロット x 2 最大メモリ容量16GB 各DIMMは 512MB & 1GB/2GB/4GB/8GB DDR3 をサポート デュアル チャンネルモードDDR3 メモリモジュール DDR3 800/1066/1333/1600/1866 をサポート 登録済みDIMMとECC DIMMはサポートされません	DDR3 DIMMスロット x 2 最大メモリ容量16GB 各DIMMは 512MB & 1GB/2GB/4GB/8GB DDR3 をサポート デュアル チャンネルモードDDR3 メモリモジュール DDR3 800/1066/1333/1600/1866 をサポート 登録済みDIMMとECC DIMMはサポートされません
Super I/O	ITE 8728 もつとも一般に使用されるレガシーSuper I/O機能を採用しています。 低ピンカウントインターフェイス 環境コントロールインシアチップ、 H/Wモニター ITEの「スマートガーディアン」機能	ITE 8728 もつとも一般に使用されるレガシーSuper I/O機能を採用しています。 低ピンカウントインターフェイス 環境コントロールインシアチップ、 H/Wモニター ITEの「スマートガーディアン」機能
SATA3/ SATA2	統合シリアルATA コントローラ 最高6Gb/秒のデータ転送速度 SATAバージョン3.0仕様標準準拠。	統合シリアルATA コントローラ 最高3Gb/秒のデータ転送速度 SATAバージョン2.0仕様標準準拠。
LAN	Realtek RTL 8111E/8111F 10 / 100 / 1000 Mb/秒のオートネゴシエーション 半/全二重機能	Realtek RTL 8111E/8111F 10 / 100 / 1000 Mb/秒のオートネゴシエーション 半/全二重機能
HDオーディオのサポート	VT1708B/ALC662 5.1チャンネルオーディオアウト ハイデフィニションオーディオのサポート	VT1708B/ALC662 5.1チャンネルオーディオアウト ハイデフィニションオーディオのサポート
USB3.0	A75	N/A
スロット	PCI Express Gen2 x16スロット x1 PCI Express Gen2 x1スロット x2 PCIスロット x1	PCI Express Gen2 x16スロット x1 PCI Express Gen2 x1スロット x2 PCIスロット x1

A75MH / A55MH

		A75MH	A55MH
オンボード コネクタ	SATA3コネクタ	x6	SATA2コネクタ x6
	フロントパネルコネクタ	x1	フロントパネルコネクタ x1
	フロントオーディオコネクタ	x1	フロントオーディオコネクタ x1
	S/PDIFアウトコネクタ	x1	S/PDIFアウトコネクタ x1
	CPUファンヘッダ	x1	CPUファンヘッダ x1
	システムファンヘッダ	x1	システムファンヘッダ x1
	CMOSクリアヘッダ	x1	CMOSクリアヘッダ x1
	USB 2.0コネクタ	x2	USB 2.0コネクタ x2
	USB 3.0コネクタ	x1	N/A
	電源コネクタ(24ピン)	x1	電源コネクタ(24ピン) x1
	電源コネクタ(4ピン)	x1	電源コネクタ(4ピン) x1
	消費者IRコネクタ	x1	消費者IRコネクタ x1
	プリンタポートコネクタ	x1	プリンタポートコネクタ x1
	シリアルポートコネクタ	x1	シリアルポートコネクタ x1
背面パネル I/O	PS/2キーボード / マウス	x1	PS/2キーボード / マウス x1
	HDMIポート	x1	HDMIポート x1
	VGAポート	x1	VGAポート x1
	DVI-Dポート	x1	DVI-Dポート x1
	LANポート	x1	LANポート x1
	USB 2.0ポート(で SB850)	x2	USB 2.0ポート x4
	USB 3.0ポート (で A75)	x2	オーディオジャック x3
	オーディオジャック	x3	
ボードサイズ	200 mm (幅) X 244 mm (高さ)	200 mm (幅) X 244 mm (高さ)	
特殊機能	RAID 0 / 1 / 10 のサポート	RAID 0 / 1 / 10 のサポート	
OSサポート	Windows XP / Vista / 7 Biostarは事前のサポートなしにOSサポートを追加または削除する権利を留保します。	Windows XP / Vista / 7 Biostarは事前のサポートなしにOSサポートを追加または削除する権利を留保します。	

2012/06/11