

FCC Information and Copyright

This equipment has been tested and found to comply with the limits of a Class B digital device, pursuant to Part 15 of the FCC Rules. These limits are designed to provide reasonable protection against harmful interference in a residential installation. This equipment generates, uses, and can radiate radio frequency energy and, if not installed and used in accordance with the instructions, may cause harmful interference to radio communications. There is no guarantee that interference will not occur in a particular installation.

The vendor makes no representations or warranties with respect to the contents here and specially disclaims any implied warranties of merchantability or fitness for any purpose. Further the vendor reserves the right to revise this publication and to make changes to the contents here without obligation to notify any party beforehand.

Duplication of this publication, in part or in whole, is not allowed without first obtaining the vendor's approval in writing.

The content of this user's manual is subject to be changed without notice and we will not be responsible for any mistakes found in this user's manual. All the brand and product names are trademarks of their respective companies.

Table of Contents

Chapter 1: Introduction	1
1.1 Before You Start	1
1.2 Package Checklist	1
1.3 Motherboard Features	2
1.4 Rear Panel Connectors	3
1.5 Motherboard Layout	4
Chapter 2: Hardware Installation	5
2.1 Installing Central Processing Unit (CPU)	5
2.2 FAN Headers	7
2.3 Installing System Memory	8
2.4 Connectors and Slots	10
Chapter 3: Headers & Jumpers Setup	13
3.1 How to Setup Jumpers	13
3.2 Detail Settings	13
Chapter 4: RAID Functions	17
4.1 Operating System	17
4.2 Raid Arrays	17
4.3 How RAID Works	17
Chapter 5: Useful Help	20
5.1 Driver Installation Note	20
5.2 Software	21
5.3 Extra Information	25
5.4 AMI BIOS Beep Code	27
5.5 Troubleshooting	28
Appendix: SPEC In Other Languages	30
German	30
French	32
Italian	34
Spanish	36
Portuguese	38
Polish	40
Russian	42
Arabic	44
Japanese	46

CHAPTER 1: INTRODUCTION

1.1 BEFORE YOU START

Thank you for choosing our product. Before you start installing the motherboard, please make sure you follow the instructions below:

- Prepare a dry and stable working environment with sufficient lighting.
- Always disconnect the computer from power outlet before operation.
- Before you take the motherboard out from anti-static bag, ground yourself properly by touching any safely grounded appliance, or use grounded wrist strap to remove the static charge.
- Avoid touching the components on motherboard or the rear side of the board unless necessary. Hold the board on the edge, do not try to bend or flex the board.
- Do not leave any unfastened small parts inside the case after installation. Loose parts will cause short circuits which may damage the equipment.
- Keep the computer from dangerous area, such as heat source, humid air and water.
- The operating temperatures of the computer should be 0 to 45 degrees Celsius.

1.2 PACKAGE CHECKLIST

- ✚ HDD Cable X 1 (optional)
- ✚ Serial ATA Cable X 2
- ✚ Rear I/O Panel for ATX Case X 1
- ✚ User's Manual X 1
- ✚ Fully Setup Driver CD X 1
- ✚ Serial ATA Power Cable X 1 (optional)
- ✚ FDD Cable X 1 (optional)
- ✚ USB 2.0 Cable X1 (optional)

Note: The package contents may be different due to area or your motherboard version.

1.3 MOTHERBOARD FEATURES

SPEC			
CPU	Socket AM3 AMD Sempron / Athlon II / Phenom II processors (Maximum Watt: 95W)		AMD 64 Architecture enables 32 and 64 bit computing Supports Hyper Transport 3.0
FSB	Support HyperTransport 3.0 Supports up to 5.2 GT/s Bandwidth		
Chipset	Northbridge: AMD 770 Southbridge: AMD SB710		
Super I/O	ITE 8721 Provides the most commonly used legacy Super I/O functionality		Low Pin Count Interface Environment Control initiatives H/W Monitor ITE's "Smart Guardian" function
Main Memory	DDR3 DIMM Slots x 2 Max Memory Capacity 8GB Each DIMM supports 512MB/ 1GB/2GB/4GB DDR3		Dual Channel Mode DDR3 memory module Supports DDR3 800 / 1066 / 1333 Supports DDR3 1600 (OC) Registered DIMM and ECC DIMM is not supported
IDE	Integrated IDE Controller		Multi-word DMA, and Ultra DMA 33/66/100/133 modes
SATA II	Integrated Serial ATA Controller		Data transfer rates up to 3 Gb/s SATA Version 2.5 specification compliant
LAN	Realtek RTL 8102EL		10 / 100 Mb/s auto negotiation Half / Full duplex capability
Sound	ALC662 / VT1708B		5.1 channels audio out High Definition Audio
Slots	PCI Express Gen2 x16 slot	x1	Supports PCI-E Gen2 x16 expansion card
	PCI Express Gen2 x1 slot	x1	Supports PCI-E Gen2 x1 expansion card
	PCI slot	x3	Supports PCI expansion cards
On Board Connector	Floppy Connector	x1	Each connector supports 1 Floppy drive
	IDE Connector	x1	Each connector supports 2 IDE device
	SATA Connector	x4	Each connector supports 1 SATA devices
	Front Panel Connector	x1	Supports front panel facilities
	Front Audio Connector	x1	Supports front panel audio function

SPEC			
	S/PDIF Out Connector	x1	Supports digital audio out function
	CPU Fan Header	x1	CPU Fan power supply (with Smart Fan function)
	System Fan Header	x1	System Fan Power supply
	CMOS Clear Header	x1	Restore CMOS data to factory default
	USB Connector	x2	Each connector supports 2 front panel USB ports
	Power Connector (24pin)	x1	Connects to Power supply
	Power Connector (4pin)	x1	Connects to Power supply
	Printer Port Connector	x1	Each connector supports 1 Printer port
Back Panel I/O	PS/2 Keyboard	x1	Connects to PS/2 Keyboard
	PS/2 Mouse	x1	Connects to PS/2 Mouse
	Serial Port	x1	Connects to RS-232 Port
	LAN Port	x1	Connect to RJ-45 ethernet cable
	USB Port	x4	Connect to USB devices
	Audio Jack	x3	Provide Audio-In/Out and microphone connection
Board Size	182 mm(W) x 305 mm(L)		ATX
Special Features	RAID 0 / 1 / 10 support		
OS Support	Windows XP / Vista / 7		Biostar reserves the right to add or remove support for any OS with or without notice.

1.4 REAR PANEL CONNECTORS

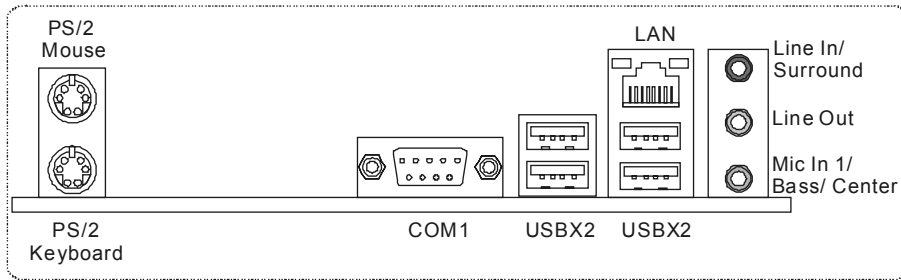

1.5 MOTHERBOARD LAYOUT

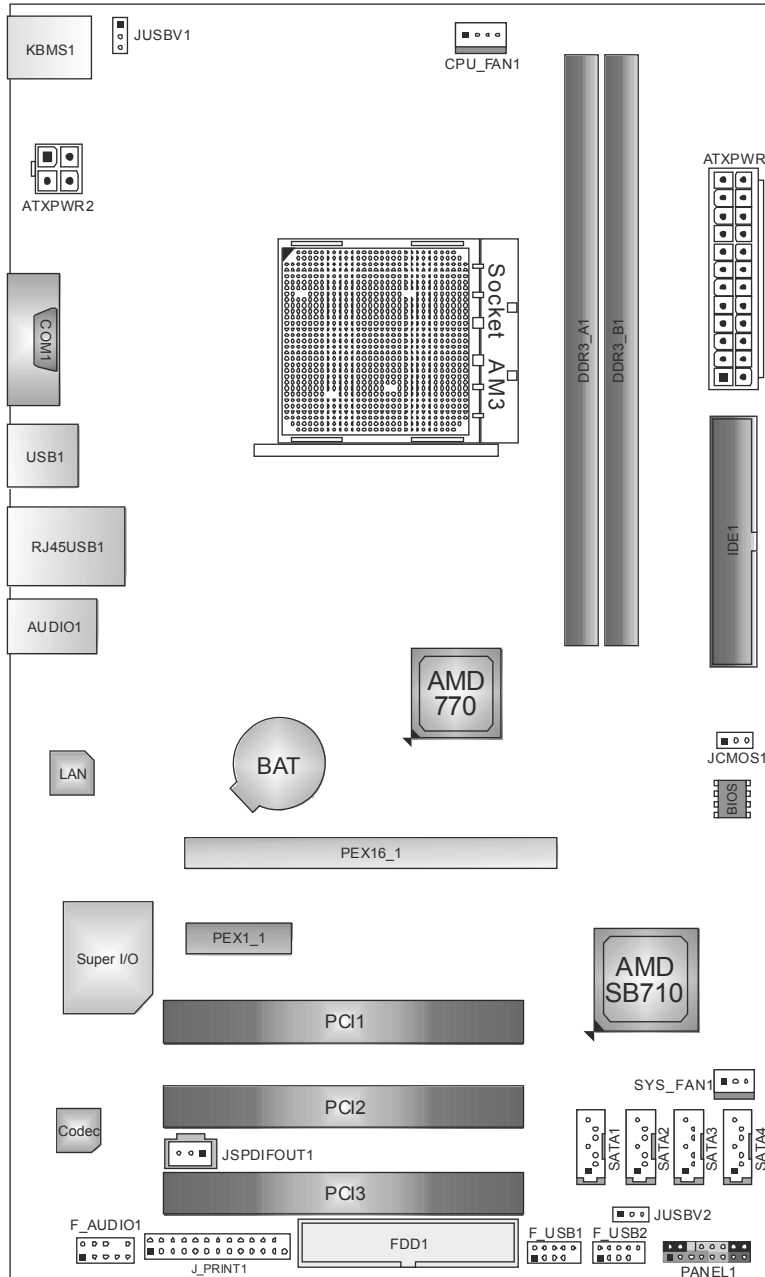

Note: ■ represents the 1st pin.

CHAPTER 2: HARDWARE INSTALLATION

2.1 INSTALLING CENTRAL PROCESSING UNIT (CPU)

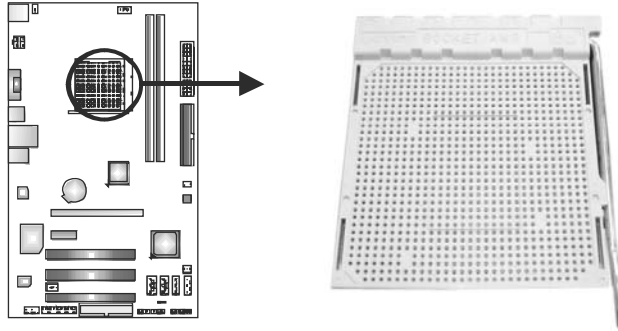

Step 1: Pull the lever toward direction A from the socket and then raise the lever up to a 90-degree angle.

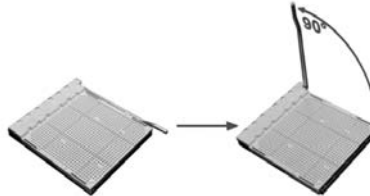

Step 2: Look for the white triangle on socket, and the gold triangle on CPU should point towards this white triangle. The CPU will fit only in the correct orientation.



Motherboard Manual

Step 3: Hold the CPU down firmly, and then close the lever toward direct B to complete the installation.



Step 4: Put the CPU Fan on the CPU and buckle it. Connect the CPU FAN power cable to the CPU_FAN1. This completes the installation.

2.2 FAN HEADERS

These fan headers support cooling-fans built in the computer. The fan cable and connector may be different according to the fan manufacturer. Connect the fan cable to the connector while matching the black wire to pin#1.

CPU_FAN1: CPU Fan Header

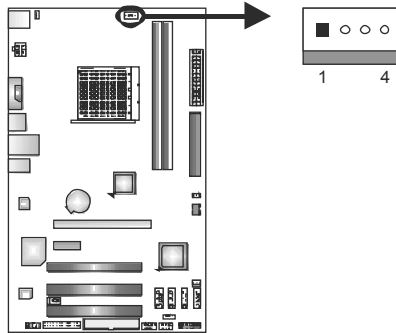

Pin	Assignment
1	Ground
2	+12V
3	FAN RPM rate sense
4	Smart Fan Control (By Fan)

SYS_FAN1: System Fan Header

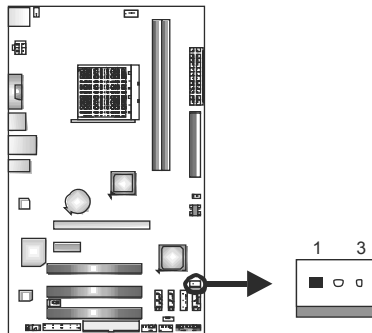

Pin	Assignment
1	Ground
2	+12V
3	FAN RPM rate sense

Note:

The CPU_FAN1 and SYS_FAN1 support 4-pin and 3-pin head connector. When connecting with wires onto connectors, please note that the red wire is the positive and should be connected to pin#2, and the black wire is Ground and should be connected to GND.

2.3 INSTALLING SYSTEM MEMORY

A. DDR3 Modules

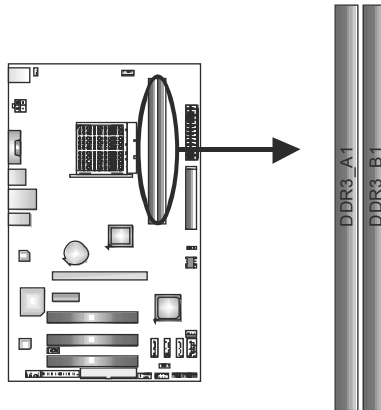

1. Unlock a DIMM slot by pressing the retaining clips outward. Align a DIMM on the slot such that the notch on the DIMM matches the break on the Slot.

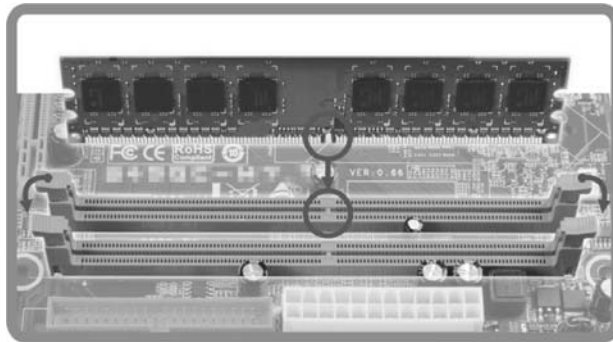

2. Insert the DIMM vertically and firmly into the slot until the retaining chip snap back in place and the DIMM is properly seated.

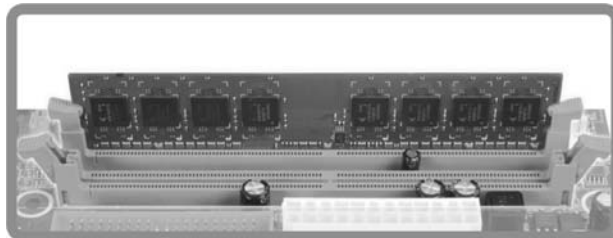

B. Memory Capacity

DIMM Socket Location	DDR3 Module	Total Memory Size
DIMMA1	512MB/1GB/2GB/4GB	Max is 8GB.
DIMMB1	512MB/1GB/2GB/4GB	

C. Dual Channel Memory installation

Please refer to the following requirements to activate Dual Channel function:

Install memory module of the same density in pairs, shown in the table..

Dual Channel Status	DDR3_A1	DDR3_B1
Disabled	O	X
Disabled	X	O
Enabled	O	O

(O means memory installed, X means memory not installed.)

The DRAM bus width of the memory module must be the same (x8 or x16)

2.4 CONNECTORS AND SLOTS

FDD1: Floppy Disk Connector

The motherboard provides a standard floppy disk connector that supports 360K, 720K, 1.2M, 1.44M and 2.88M floppy disk types.

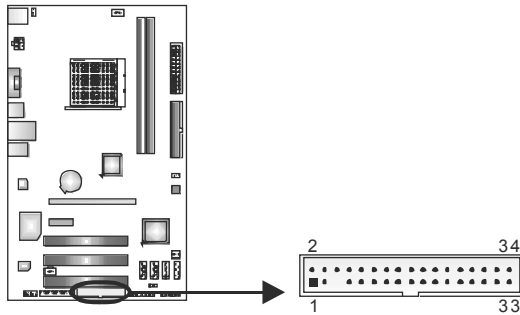

IDE1: Hard Disk Connector

The motherboard has a 32-bit Enhanced IDE Controller that provides PIO Mode 0~4, Bus Master, Multi-word DMA, and Ultra DMA 33/66/100/133 functionality.

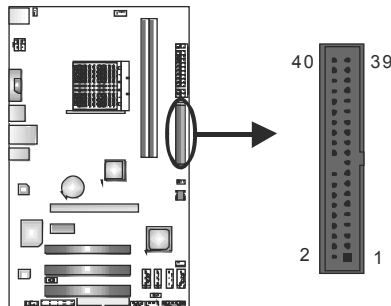

SATA1~SATA4: Serial ATA Connectors

The motherboard has a PCI to SATA Controller with 4 channels SATA interface, it satisfies the SATA 2.5 spec and with transfer rate of 3.0Gb/s.

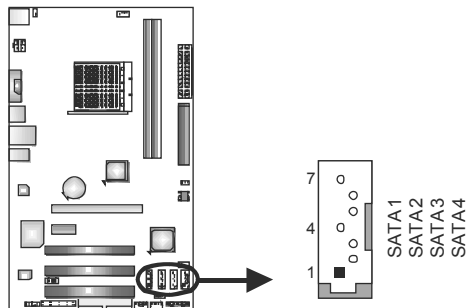

Pin	Assignment
1	Ground
2	TX+
3	TX-
4	Ground
5	RX-
6	RX+
7	Ground

ATXPWR1: ATX Power Source Connector

This connector allows user to connect 24-pin power connector on the ATX power supply.

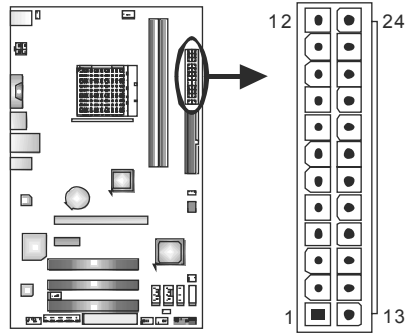

Pin	Assignment	Pin	Assignment
13	+3.3V	1	+3.3V
14	-12V	2	+3.3V
15	Ground	3	Ground
16	PS_ON	4	+5V
17	Ground	5	Ground
18	Ground	6	+5V
19	Ground	7	Ground
20	NC	8	PW_OK
21	+5V	9	Standby Voltage+5V
22	+5V	10	+12V
23	+5V	11	+12V
24	Ground	12	+3.3V

ATXPWR2: ATX Power Source Connector

This connector provides +12V to CPU power circuit.

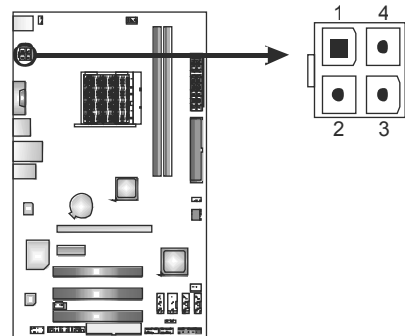

Pin	Assignment
1	+12V
2	+12V
3	Ground
4	Ground

PEX16_1: PCI-Express Gen2 x16 Slot

- PCI-Express 2.0 compliant.
- Maximum theoretical realized bandwidth of 8GB/s simultaneously per direction, for an aggregate of 16GB/s totally.

PEX1_1: PCI-Express Gen2 x1 Slot

- PCI-Express 2.0 compliant.
- Data transfer bandwidth up to 250MB/s per direction; 500MB/s in total.
- PCI-Express Gen2 supports a raw bit-rate of 2.5Gb/s on the data pins.
- 2X bandwidth over the PCI-Express 1.0 architecture.

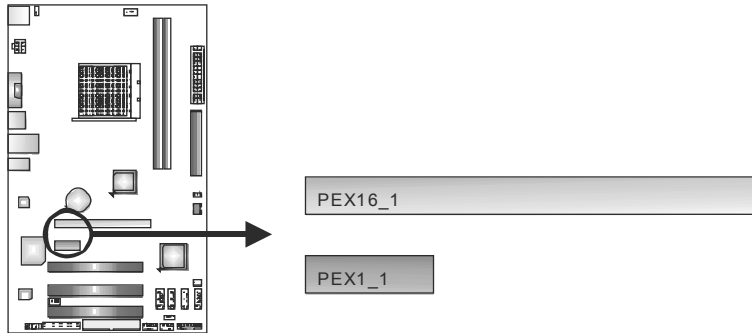

PCI1~PCI3: Peripheral Component Interconnect Slots

This motherboard is equipped with 3 standard PCI slots. PCI stands for Peripheral Component Interconnect, and it is a bus standard for expansion cards. This PCI slot is designated as 32 bits.

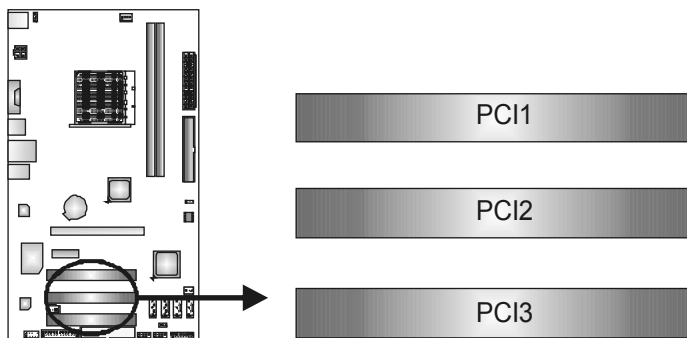

CHAPTER 3: HEADERS & JUMPERS SETUP

3.1 HOW TO SETUP JUMPERS

The illustration shows how to set up jumpers. When the jumper cap is placed on pins, the jumper is “close”, if not, that means the jumper is “open”.



Pin opened



Pin closed



Pin1-2 closed

3.2 DETAIL SETTINGS

PANEL1: Front Panel Header

This 16-pin connector includes Power-on, Reset, HDD LED, Power LED, and speaker connection. It allows user to connect the PC case's front panel switch functions.

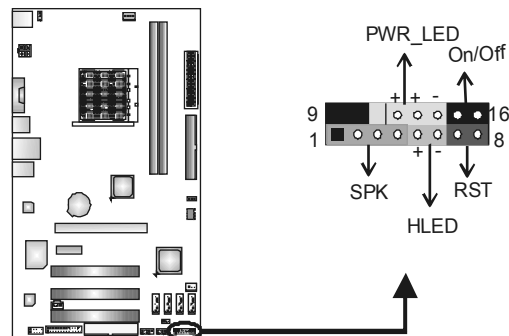

Pin	Assignment	Function	Pin	Assignment	Function
1	+5V	Speaker Connector	9	N/A	N/A
2	N/A		10	N/A	N/A
3	N/A		11	N/A	N/A
4	Speaker	Hard drive LED	12	Power LED (+)	Power LED
5	HDD LED (+)		13	Power LED (+)	
6	HDD LED (-)		14	Power LED (-)	
7	Ground	Reset button	15	Power button	Power-on button
8	Reset control		16	Ground	

F_AUDIO1: Front Panel Audio Header

This header allows user to connect the front audio output cable with the PC front panel. This header allows only HD audio front panel connector.

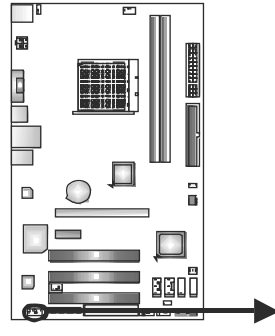

Pin	Assignment
1	Mic Left in
2	Ground
3	Mic Right in
4	GPIO
5	Right line in
6	Jack Sense
7	Front Sense
8	Key
9	Left line in
10	Jack Sense

JSPDIFOUT1: Digital Audio-out Connector

This connector allows user to connect the PCI bracket SPDIF output header.

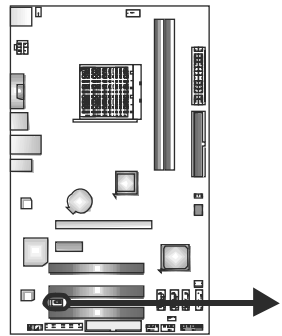

Pin	Assignment
1	Left Channel Input
2	Ground
3	Ground
4	Right Channel Input

F_USB1/F_USB2: Headers for USB 2.0 Ports at Front Panel

This header allows user to connect additional USB cable on the PC front panel, and also can be connected with internal USB devices, like USB card reader.

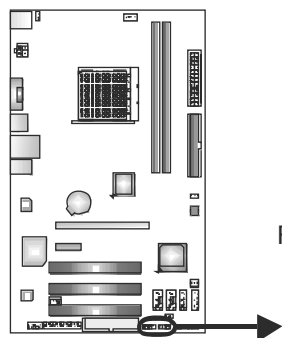

Pin	Assignment
1	+5V (fused)
2	+5V (fused)
3	USB-
4	USB-
5	USB+
6	USB+
7	Ground
8	Ground
9	Key
10	NC

JUSBV1/JUSBV2: Power Source Headers for USB Ports

Pin 1-2 Close:

JUSBV1: +5V for USB ports at USB1/RJ45USB1.

JUSBV2: +5V for USB ports at F_USB1/F_USB2.

Pin 2-3 Close:

JUSBV1: +5V STB for USB ports at USB1/RJ45USB1.

JUSBV2: +5V STB for USB ports at F_USB1/F_USB2.

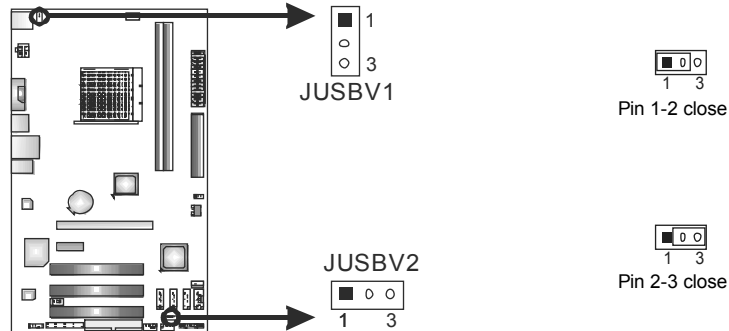

JCMOS1: Clear CMOS Header

Placing the jumper on pin2-3, it allows user to restore the BIOS safe setting and the CMOS data. Please carefully follow the procedures to avoid damaging the motherboard.

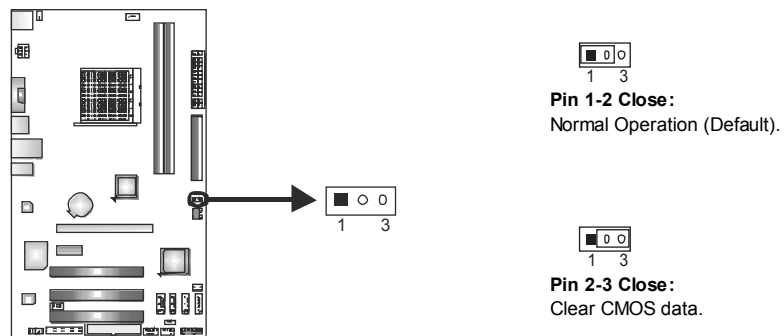

※ Clear CMOS Procedures:

1. Remove AC power line.
2. Set the jumper to "Pin 2-3 close".
3. Wait for five seconds.
4. Set the jumper to "Pin 1-2 close".
5. Power on the AC.
6. Reset your desired password or clear the CMOS data.

J_PRINT1: Printer Port Connector

This header allows you to connector printer on the PC.

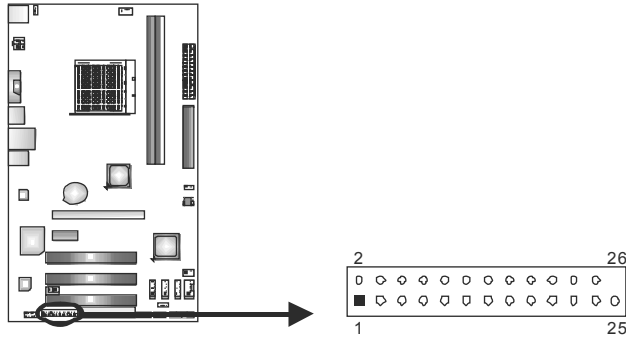

Pin	Assignment	Pin	Assignment
1	-Strobe	14	Ground
2	-ALF	15	Data 6
3	Data 0	16	Ground
4	-Error	17	Data 7
5	Data 1	18	Ground
6	-Init	19	-ACK
7	Data 2	20	Ground
8	-Scltin	21	Busy
9	Data 3	22	Ground
10	Ground	23	PE
11	Data 4	24	Ground
12	Ground	25	SCLT
13	Data 5	26	Key

CHAPTER 4: RAID FUNCTIONS

4.1 OPERATING SYSTEM

Supports Windows XP, Windows Vista, and Windows 7.

4.2 RAID ARRAYS

RAID supports the following types of RAID arrays:

RAID 0: RAID 0 defines a disk striping scheme that improves disk read and write times for many applications.

RAID 1: RAID 1 defines techniques for mirroring data.

RAID 10: RAID 10 combines the techniques used in RAID 0 and RAID 1.

4.3 How RAID WORKS

RAID 0:

The controller “stripes” data across multiple drives in a RAID 0 array system. It breaks up a large file into smaller blocks and performs disk reads and writes across multiple drives in parallel. The size of each block is determined by the stripe size parameter, which you set during the creation of the RAID set based on the system environment. This technique reduces overall disk access time and offers high bandwidth.

Features and Benefits

- **Drives:** Minimum 1, and maximum is up to 6 or 8. Depending on the platform.
- **Uses:** Intended for non-critical data requiring high data throughput, or any environment that does not require fault tolerance.
- **Benefits:** provides increased data throughput, especially for large files. No capacity loss penalty for parity.
- **Drawbacks:** Does not deliver any fault tolerance. If any drive in the array fails, all data is lost.
- **Fault Tolerance:** No.

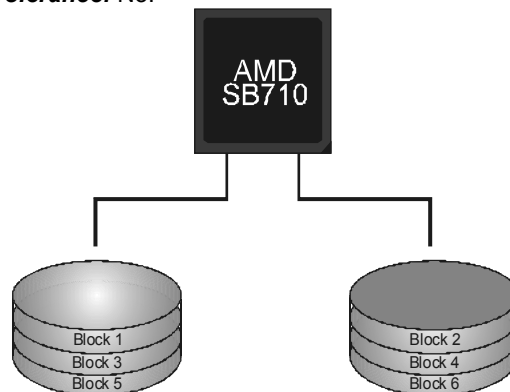

RAID 1:

Every read and write is actually carried out in parallel across 2 disk drives in a RAID 1 array system. The mirrored (backup) copy of the data can reside on the same disk or on a second redundant drive in the array. RAID 1 provides a hot-standby copy of data if the active volume or drive is corrupted or becomes unavailable because of a hardware failure. RAID techniques can be applied for high-availability solutions, or as a form of automatic backup that eliminates tedious manual backups to more expensive and less reliable media.

Features and Benefits

- **Drives:** Minimum 2, and maximum is 2.
- **Uses:** RAID 1 is ideal for small databases or any other application that requires fault tolerance and minimal capacity.
- **Benefits:** Provides 100% data redundancy. Should one drive fail, the controller switches to the other drive.
- **Drawbacks:** Requires 2 drives for the storage space of one drive. Performance is impaired during drive rebuilds.
- **Fault Tolerance:** Yes.

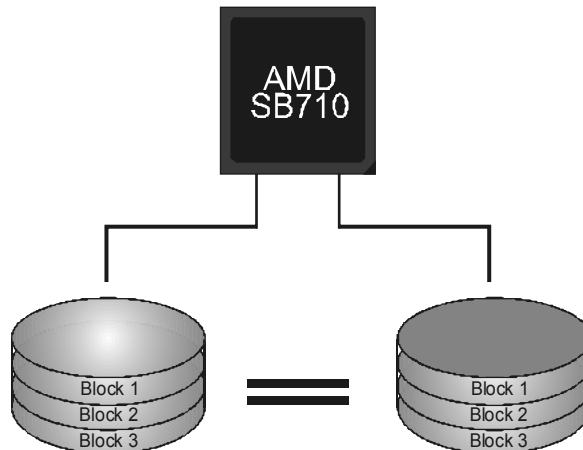

RAID 10:

RAID 1 drives can be striped using RAID 0 techniques. Resulting in a RAID 10 solution for improved resiliency, performance and rebuild performance.

Features and Benefits

- **Drives:** Minimum 4, and maximum is 6 or 8, depending on the platform.
- **Benefits:** Optimizes for both fault tolerance and performance, allowing for automatic redundancy. May be simultaneously used with other RAID levels in an array, and allows for spare disks.
- **Drawbacks:** Requires twice the available disk space for data redundancy, the same as RAID level 1.
- **Fault Tolerance:** Yes.

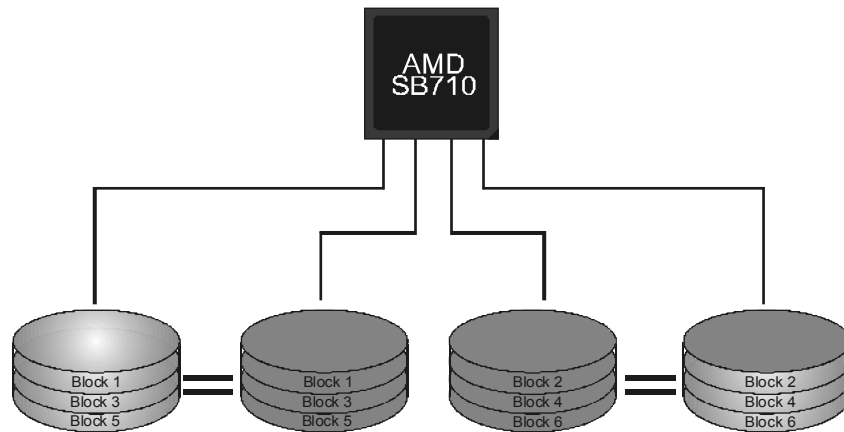

CHAPTER 5: USEFUL HELP

5.1 DRIVER INSTALLATION NOTE

After you installed your operating system, please insert the Fully Setup Driver CD into your optical drive and install the driver for better system performance.

You will see the following window after you insert the CD



The setup guide will auto detect your motherboard and operating system.

Note:

If this window didn't show up after you insert the Driver CD, please use file browser to locate and execute the file **SETUP.EXE** under your optical drive.

A. Driver Installation

To install the driver, please click on the Driver icon. The setup guide will list the compatible driver for your motherboard and operating system. Click on each device driver to launch the installation program.

B. Software Installation

To install the software, please click on the Software icon. The setup guide will list the software available for your system, click on each software title to launch the installation program.

C. Manual

Aside from the paperback manual, we also provide manual in the Driver CD. Click on the Manual icon to browse for available manual.

Note:

You will need Acrobat Reader to open the manual file. Please download the latest version of Acrobat Reader software from <http://www.adobe.com/products/acrobat/readstep2.html>

5.2 SOFTWARE

Installing Software

1. Insert the Setup CD to the optical drive. The drivers installation program would appear if the Autorun function has been enabled.
2. Select **Software Installation**, and then click on the respective software title.
3. Follow the on-screen instructions to complete the installation.

Launching Software

After the installation process, you will see the software icon “eHOT Line” / “BIOS Update” appears on the desktop. Double-click the icon to launch the utility.

eHot-Line (Optional)

eHot-Line is a convenient utility that helps you to contact with our Tech-Support system. This utility will collect the system information which is useful for analyzing the problem you may have encountered, and then send these information to our tech-support department to help you fix the problem.

 Before you use this utility, please set Outlook Express as your default e-mail client application program.

*represents important information that you must provide. Without this information, you may not be able to send out the mail.

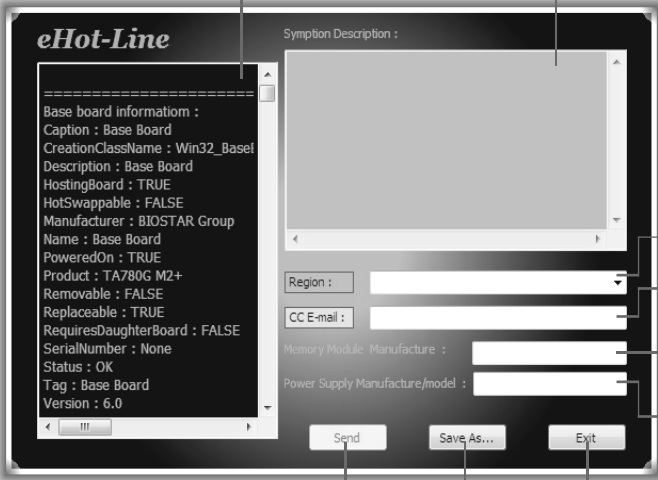

The screenshot shows the eHot-Line utility window. On the left, there is a list of system information under the heading "Base board information :". On the right, there is a "Symptom Description :" text area. Below the text area are several input fields: "Region :", "CC E-mail :", "Memory Module Manufacture :", and "Power Supply Manufacture/model :". At the bottom, there are three buttons: "Send", "Save As...", and "Exit".

Annotations for the screenshot:

- "This block will show the information which would be collected in the mail." points to the system information list.
- "*Describe condition of your system." points to the Symptom Description text area.
- "*Select your area or the area close to you." points to the Region dropdown menu.
- "Provide the e-mail address that you would like to send the copy to." points to the CC E-mail input field.
- "*Provide the name of the memory module manufacturer." points to the Memory Module Manufacture input field.
- "Provide the name of the power supply manufacturer and the model no." points to the Power Supply Manufacture/model input field.
- "Send the mail out." points to the Send button.
- "Save these information to a .txt file" points to the Save As... button.
- "Exit this dialog." points to the Exit button.

Motherboard Manual

After filling up this information, click **“Send”** to send the mail out. A warning dialog would appear asking for your confirmation; click **“Send”** to confirm or **“Do Not Send”** to cancel.



If you want to save this information to a .txt file, click **“Save As...”** and then you will see a saving dialog appears asking you to enter file name.

Enter the file name and then click **“Save”**. Your system information will be saved to a .txt file.

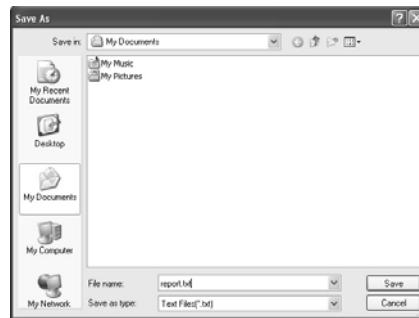

Open the saved .txt file, you will see your system information including motherboard/BIOS/CPU/video/device/OS information. This information is also concluded in the sent mail.



We will not share customer’s data with any other third parties, so please feel free to provide your system information while using eHot-Line service.



If you are not using Outlook Express as your default e-mail client application, you may need to save the system information to a .txt file and send the file to our tech support with other e-mail application. Go to the following web <http://www.biostar.com.tw/app/en-us/about/contact.php> for getting our contact information.

BIOS Update

BIOS Update is a convenient utility which allows you to update your motherboard BIOS under Windows system.

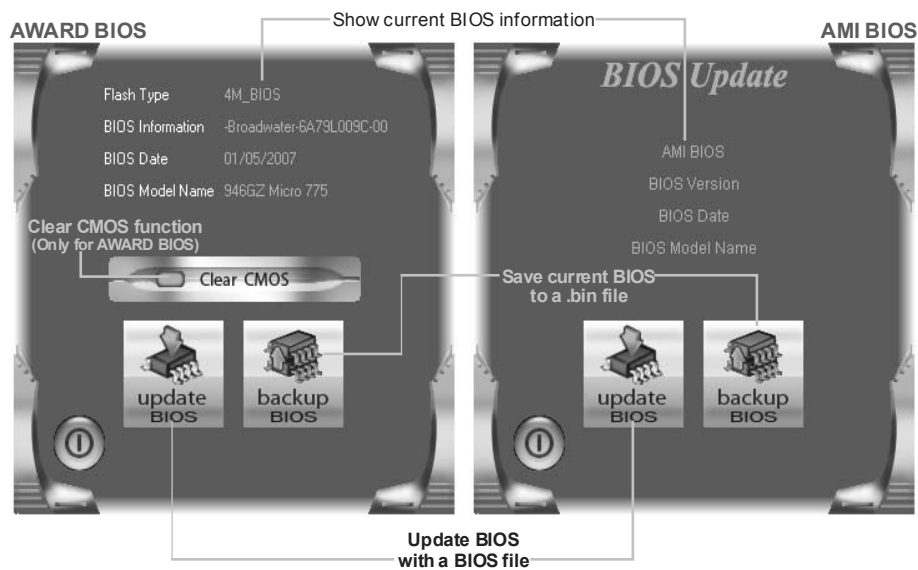

<Backup BIOS>

Once click on this button, the saving dialog will show. Choose the position to save file and enter file name. (We recommend that the file name should be English/number and no longer than 7 characters.) Then click **Save**.

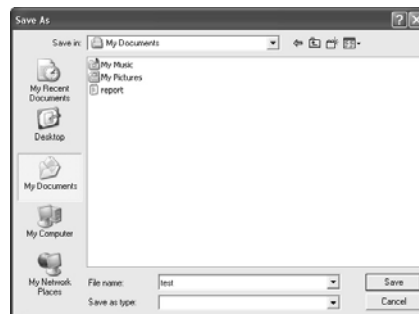

<Update BIOS>

Before doing this, please download the proper BIOS file from the website.

For AWARD BIOS, update BIOS procedure should be run with Clear CMOS function, so please check on Clear CMOS first.

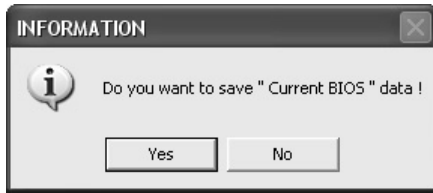
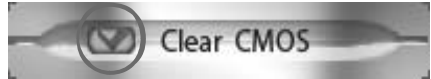

Then click Update BIOS button, a dialog will show for asking you backup current BIOS. Click **Yes** for BIOS backup and refer to the Backup BIOS procedure; or click **No** to skip this procedure.

After the BIOS Backup procedure, the open dialog will show for requesting the BIOS file which is going to be updated. Please choose the proper BIOS file for updating, then click on **Open**.

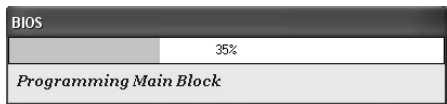
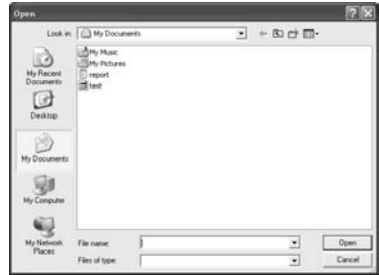

The utility will update BIOS with the proper BIOS file, and this process may take minutes. Please do not open any other applications during this process.

After the BIOS Update process, click on **OK** to restart the system.

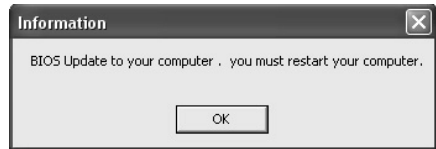

While the system boots up and the full screen logo shows, press  <Delete> key to enter BIOS setup.

In the BIOS setup, use the **Load Optimized Defaults** function and then **Save and Exit Setup** to exit BIOS setup. BIOS Update is completed.



All the information and content above about the software are subject to be changed without notice. For better performance, the software is being continuously updated. The information and pictures described above are for your reference only. The actual information and settings on board may be slightly different from this manual.

5.3 EXTRA INFORMATION

CPU Overheated

If the system shutdown automatically after power on system for seconds, that means the CPU protection function has been activated.

When the CPU is over heated, the motherboard will shutdown automatically to avoid a damage of the CPU, and the system may not power on again.

In this case, please double check:

1. The CPU cooler surface is placed evenly with the CPU surface.
2. CPU fan is rotated normally.
3. CPU fan speed is fulfilling with the CPU speed.

After confirmed, please follow steps below to relief the CPU protection function.

1. Remove the power cord from power supply for seconds.
2. Wait for seconds.
3. Plug in the power cord and boot up the system.

Or you can:

1. Clear the CMOS data.
(See "Close CMOS Header: JCMOS1" section)
2. Wait for seconds.
3. Power on the system again.

BIO-Flasher

BIO-Flasher is a BIOS flashing utility providing you an easy and simple way to update your BIOS via USB pen drive or floppy disk.

The BIO-Flasher is built in the BIOS chip. To enter the utility, **press <F12> during the Power-On Self Tests (POST)** procedure while booting up.

Updating BIOS with BIO-Flasher

1. Go to the website to download the latest BIOS file for the motherboard.
2. Then, save the BIOS file into a USB pen drive or a floppy disk.
3. Insert the USB pen drive or the floppy disk that contains the BIOS file to the USB port or the floppy disk drive.
4. Power on or reset the computer and then press **<F12>** during the **POST** process. A select dialog as the picture on the right appears. Select the device contains the BIOS file and press **<Enter>** to enter the utility.



5. The utility will show the BIOS files and their respective information. Select the proper BIOS file and press **<Enter>** then **<Y>** to perform the BIOS update process.

6. After the update process, the utility will ask you to reboot the system. Press **<Y>** to proceed. BIOS update completes.



- This utility only allows storage device with FAT32/16 format and single partition.
- Shutting down or resetting the system while updating the BIOS will lead to system boot failure.

5.4 AMI BIOS BEEP CODE

Boot Block Beep Codes

Number of Beeps	Description
1	No media present. (Insert diskette in floppy drive A:)
2	"AMIBOOT.ROM" file not found in root directory of diskette in A:
3	Insert next diskette if multiple diskettes are used for recovery
4	Flash Programming successful
5	File read error
7	No Flash EPROM detected
10	Flash Erase error
11	Flash Program error
12	"AMIBOOT.ROM" file size error
13	BIOS ROM image mismatch (file layout does not match image present in flash device)

POST BIOS Beep Codes

Number of Beeps	Description
1	Memory refresh timer error
3	Base memory read/write test error
6	Keyboard controller BAT command failed
7	General exception error (processor exception interrupt error)
8	Display memory error (system video adapter)

Troubleshooting POST BIOS Beep Codes

Number of Beeps	Troubleshooting Action
1, 3	Reseat the memory, or replace with known good modules.
6, 7	<p>Fatal error indicating a serious problem with the system. Consult your system manufacturer. Before declaring the motherboard beyond all hope, eliminate the possibility of interference by a malfunctioning add-in card. Remove all expansion cards except the video adapter.</p> <ul style="list-style-type: none"> ● If beep codes are generated when all other expansion cards are absent, consult your system manufacturer's technical support. ● If beep codes are not generated when all other expansion cards are absent, one of the add-in cards is causing the malfunction. Insert the cards back into the system one at a time until the problem happens again. This will reveal the malfunctioning card.
8	If the system video adapter is an add-in card, replace or reseat the video adapter. If the video adapter is an integrated part of the system board, the board may be faulty.

5.5 TROUBLESHOOTING

Probable	Solution
<ol style="list-style-type: none"> 1. There is no power in the system. Power LED does not shine; the fan of the power supply does not work 2. Indicator light on keyboard does not shine. 	<ol style="list-style-type: none"> 1. Make sure power cable is securely plugged in. 2. Replace cable. 3. Contact technical support.
<p>System is inoperative. Keyboard lights are on, power indicator lights are lit, and hard drives are running.</p>	<p>Using even pressure on both ends of the DIMM, press down firmly until the module snaps into place.</p>
<p>System does not boot from a hard disk drive, but can be booted from optical drive.</p>	<ol style="list-style-type: none"> 1. Check cable running from disk to disk controller board. Make sure both ends are securely plugged in; check the drive type in the standard CMOS setup. 2. Backing up the hard drive is extremely important. All hard disks are capable of breaking down at any time.
<p>System only boots from an optical drive. Hard disks can be read, applications can be used, but system fails to boot from a hard disk.</p>	<ol style="list-style-type: none"> 1. Back up data and applications files. 2. Reformat the hard drive. Re-install applications and data using backup disks.
<p>Screen message shows "Invalid Configuration" or "CMOS Failure."</p>	<p>Review system's equipment. Make sure correct information is in setup.</p>
<p>System cannot boot after user installs a second hard drive.</p>	<ol style="list-style-type: none"> 1. Set master/slave jumpers correctly. 2. Run SETUP program and select correct drive types. Call the drive manufacturers for compatibility with other drives.

This page is intentionally left blank.

APPENDIX: SPEC IN OTHER LANGUAGES

GERMAN

<i>Spezifikationen</i>		
CPU	Sockel AM3 AMD Sempron / Athlon II / Phenom II Prozessoren (Maximales Watt: 95W)	Die AMD 64-Architektur unterstützt eine 32-Bit- und 64-Bit-Datenverarbeitung Unterstützt Hyper Transport 3.0
FSB	Unterstützt HyperTransport 3.0 mit einer Bandbreite von bis zu 5.2 GT/s	
Chipsatz	AMD 770 AMD SB710	
Super E/A	ITE 8721 Bietet die häufig verwendeten alten Super E/A-Funktionen. Low Pin Count-Schnittstelle	Umgebungskontrolle, Hardware-Überwachung Lüfterdrehzahl-Controller "Smart Guardian"-Funktion von ITE
Arbeitsspeicher	DDR3 DIMM-Steckplätze x 2 Max. 8GB Arbeitsspeicher Jeder DIMM unterstützt 512MB/ 1GB/2GB/4GB DDR3.	Dual-Kanal DDR3 Speichermodul Unterstützt DDR3 800 / 1066 / 1333 Unterstützt DDR3 1600 (OC) registrierte DIMMs. ECC DIMMs werden nicht unterstützt.
IDE	Integrierter IDE-Controller	Ultra DMA 33 / 66 / 100 / 133 Bus Master-Modus Unterstützt PIO-Modus 0~4,
SATA II	Integrierter Serial ATA-Controller	Datentransferrate bis zu 3Gb/s Konform mit der SATA-Spezifikation Version 2.0. Unterstützt RAID 0,1,10
LAN	Realtek RTL 8102EL	10 / 100 Mb/s Auto-Negotiation Halb- / Vollduplex-Funktion
Audio-Codec	ALC662 / VT1708B	5.1-Kanal-Audioausgabe Unterstützt High-Definition Audio
Steckplätze	PCI Steckplatz x3 PCI Express Gen2 x16 Steckplatz x1 PCI Express Gen2x1 Steckplatz x1	

Spezifikationen			
Onboard-Anschluss	Diskettenlaufwerkanschluss	x1	Jeder Anschluss unterstützt 1 Diskettenlaufwerke
	Druckeranschluss Anschluss	x1	Jeder Anschluss unterstützt 1 Druckeranschluss
	IDE-Anschluss	x1	Jeder Anschluss unterstützt 2 IDE-Laufwerke
	SATA-Anschluss	x4	Jeder Anschluss unterstützt 1 SATA-Laufwerk
	Fronttafelanschluss	x1	Unterstützt die Fronttafelaktionen
	Front-Audioanschluss	x1	Unterstützt die Fronttafel-Audioanschlussfunktion
	S/PDIF- Ausgangsanschluss	x1	Unterstützt die digitale Audioausgabefunktion
	CPU-Lüfter-Sockel	x1	CPU-Lüfterstromversorgungsanschluss (mit Smart Fan-Funktion)
	System-Lüfter-Sockel	x2	System-Lüfter-Stromversorgungsanschluss
	"CMOS löschen"-Sockel	x1	
	USB-Anschluss	x2	Jeder Anschluss unterstützt 2 Fronttafel-USB-Anschlüsse
	Stromanschluss (24-polig)	x1	
Stromanschluss (4-polig)	x1		
Rückseiten-E/A	PS/2-Tastatur	x1	
	PS/2-Maus	x1	
	Serieller Anschluss	x1	
	LAN-Anschluss	x1	
	USB-Anschluss	x4	
	Audioanschluss	x3	
Platinengröße	182 mm (B) X 305 mm (L)		ATX
OS-Unterstützung	Windows XP / Vista / 7		Biostar behält sich das Recht vor, ohne Ankündigung die Unterstützung für ein Betriebssystem hinzuzufügen oder zu entfernen.

FRENCH

SPEC		
UC	Socket AM3 Processeurs AMD Sempron / Athlon II / Phenom II (Watt maximum : 95W)	L'architecture AMD 64 permet le calcul 32 et 64 bits Prend en charge Hyper Transport 3.0
Bus frontal	Prend en charge Hyper Transport 3.0 jusqu'à une bande passante de 5.2 GT/s	
Chipset	AMD 770 AMD SB710	
Super E/S	ITE 8721 Fournit la fonctionnalité de Super E/S patrimoniales la plus utilisée. Interface à faible compte de broches	Initiatives de contrôle environnementales, Moniteur de matériel Contrôleur de vitesse de ventilateur Fonction "Gardien intelligent" de l'ITE
Mémoire principale	Fentes DDR3 DIMM x 2 Capacité mémoire maximale de 8 Go Chaque DIMM prend en charge des DDR3 de 512Mo/1Go/2Go/4Go	Module de mémoire DDR3 à mode à double voie Prend en charge la DDR3 800 / 1066 / 1333 Prend en charge la DDR3 1600 (OC) Les DIMM à registres et DIMM avec code correcteurs d'erreurs ne sont pas prises en charge
IDE	Contrôleur IDE intégré	Mode principale de Bus Ultra DMA 33 / 66 / 100 / 133 Prend en charge le mode PIO 0~4,
SATA II	Contrôleur Serial ATA intégré	Taux de transfert jusqu'à 3 Go/s. Conforme à la spécification SATA Version 2.0 Prise en charge RAID 0,1,10
LAN	Realtek RTL 8102EL	10 / 100 Mb/s négociation automatique Half / Full duplex capability
Codec audio	ALC662 / VT1708B	Sortie audio à 5.1 voies Prise en charge de l'audio haute définition
Fentes	Fente PCI x3 Fente PCI Express Gen2 x16 x1 Fente PCI Express Gen2 x1 x1	

SPEC			
Connecteur embarqué	Connecteur de disquette	x1	Chaque connector prend en charge 1 lecteur de disquette
	Connecteur de Port d'imprimante	x1	Chaque connector prend en charge 1 Port d'imprimante
	Connecteur IDE	x1	Chaque connecteur prend en charge 2 périphériques IDE
	Connecteur SATA	x4	Chaque connecteur prend en charge 1 périphérique SATA
	Connecteur du panneau avant	x1	Prend en charge les équipements du panneau avant
	Connecteur Audio du panneau avant	x1	Prend en charge la fonction audio du panneau avant
	Connecteur de sortie S/PDIF	x1	Prend en charge la fonction de sortie audio numérique
	Embase de ventilateur UC	x1	Alimentation électrique du ventilateur UC (avec fonction de ventilateur intelligent)
	Embase de ventilateur système	x2	Alimentation électrique du ventilateur système
	Embase d'effacement CMOS	x1	
	Connecteur USB	x2	Chaque connecteur prend en charge 2 ports USB de panneau avant
	Connecteur d'alimentation (24 broches)	x1	
	Connecteur d'alimentation (4 broches)	x1	
E/S du panneau arrière	Clavier PS/2	x1	
	Souris PS/2	x1	
	Port série	x1	
	Port LAN	x1	
	Port USB	x4	
	Fiche audio	x3	
Dimensions de la carte	182 mm (l) X 305 mm (H)	ATX	
Support SE	Windows XP / Vista / 7		Biostar se réserve le droit d'ajouter ou de supprimer le support de SE avec ou sans préavis.

ITALIAN

SPECIFICA		
CPU	Socket AM3 Processori AMD Sempron / Athlon II / Phenom II (Watt massimo: 95W)	L'architettura AMD 64 abilita la computazione 32 e 64 bit Supporto di Hyper Transport 3.0
FSB	Supporto di HyperTransport 3.0 fino a 5.2 GT/s di larghezza di banda	
Chipset	AMD 770 AMD SB710	
Super I/O	ITE 8721 Fornisce le funzionalità legacy Super I/O usate più comunemente. Interfaccia LPC (Low Pin Count)	Funzioni di controllo dell'ambiente: Monitoraggio hardware Controller velocità ventolina Funzione "Smart Guardian" di ITE
Memoria principale	Alloggi DIMM DDR3 x 2 Capacità massima della memoria 8GB Ciascun DIMM supporta DDR3 512MB/1GB/2GB/4GB	Modulo di memoria DDR3 a canale doppio Supporto di DDR3 800 / 1066 / 1333 Supporto di DDR3 1600 (OC) DIMM registrati e DIMM ECC non sono supportati
IDE	Controller IDE integrato	Modalità Bus Master Ultra DMA 33 / 66 / 100 / 133 Supporto modalità PIO Mode 0-4
SATA II	Controller Serial ATA integrato	Velocità di trasferimento dei dati fino a 3 Gb/s. Compatibile specifiche SATA Versione 2.0. Supporto RAID 0,1,10
LAN	Realtek RTL 8102EL	Negoziazione automatica 10 / 100 Mb/s Capacità Half / Full Duplex
Codec audio	ALC662 / VT1708B	Uscita audio 5.1 canali Supporto audio High-Definition (HD)
Alloggi	Alloggio PCI x3 Alloggio PCI Express Gen2 x16 x1 Alloggio PCI Express Gen2x1 x1	

SPECIFICA			
Connettori su scheda	Connettore floppy	x1	Ciascun connettore supporta 1 unità Floppy
	Connettore Porta stampante	x1	Ciascun connettore supporta 1 Porta stampante
	Connettore IDE	x1	Ciascun connettore supporta 2 unità IDE
	Connettore SATA	x4	Ciascun connettore supporta 1 unità SATA
	Connettore pannello frontale	x1	Supporta i servizi del pannello frontale
	Connettore audio frontale	x1	Supporta la funzione audio pannello frontale
	Connettore output SPDIF	x1	Supporta la funzione d'output audio digitale
	Collettore ventolina CPU	x1	Alimentazione ventolina CPU (con funzione Smart Fan)
	Collettore ventolina sistema	x2	Alimentazione ventolina di sistema
	Collettore cancellazione CMOS	x1	
I/O pannello posteriore	Connettore USB	x2	Ciascun connettore supporta 2 porte USB pannello frontale
	Connettore alimentazione (24 pin)	x1	
	Connettore alimentazione (4 pin)	x1	
	Tastiera PS/2	x1	
I/O pannello posteriore	Mouse PS/2	x1	
	Porta seriale	x1	
	Porta LAN	x1	
	Porta USB	x4	
	Connettore audio	x3	
Dimensioni i scheda	182 mm (larghezza) x 305 mm (altezza)		ATX
Sistemi operativi supportati	Windows XP / Vista / 7		Biostar si riserva il diritto di aggiungere o rimuovere il supporto di qualsiasi sistema operativo senza preavviso.

SPANISH

<i>Especificación</i>		
CPU	Conector AM3 Procesadores AMD Sempron / Athlon II / Phenom II (Vatio máximo: 95W)	La arquitectura AMD 64 permite el procesado de 32 y 64 bits Soporta las tecnologías Hyper Transport 3.0
FSB	Admite HyperTransport 3.0 con un ancho de banda de hasta 5.2 GT/s	
Conjunto de chips	AMD 770 AMD SB710	
Súper E/S	ITE 8721 Le ofrece las funcionalidades heredadas de uso más común Súper E/S. Interfaz de cuenta Low Pin	Iniciativas de control de entorno, Monitor hardware Controlador de velocidad de ventilador Función "Guardia inteligente" de ITE
Memoria principal	Ranuras DIMM DDR3 x 2 Capacidad máxima de memoria de 8GB Cada DIMM admite DDR de 512MB/1GB/2GB/4GB	Módulo de memoria DDR3 de canal Doble Admite DDR3 de 800 / 1066 / 1333 Admite DDR3 de 1600 (OC) No admite DIMM registrados o DIMM compatibles con ECC
IDE	Controlador IDE integrado	Modo bus maestro Ultra DMA 33 / 66 / 100 / 133 Soporte los Modos PIO 0~4,
SATA II	Controlador Serial ATA integrado	Tasas de transferencia de hasta 3 Gb/s. Compatible con la versión SATA 2.0. Admite RAID 0,1,10
Red Local	Realtek RTL 8102EL	Negociación de 10 / 100 Mb/s Funciones Half / Full dúplex
Códecs de sonido	ALC662 / VT1708B	Salida de sonido de 5.1 canales Soporte de sonido de Alta Definición
Ranuras	Ranura PCI X3 Ranura PCI Express Gen2 x16 X1 Ranura PCI express Gen2 x1 X1	

Especificación			
Conectores en placa	Conector disco flexible	X1	Cada conector soporta 1 unidad de disco flexible
	Conector Puerto de impresora	X1	Cada conector soporta 1 Puerto de impresora
	Conector IDE	X1	Cada conector soporta 2 dispositivos IDE
	Conector SATA	X4	Cada conector soporta 1 dispositivos SATA
	Conector de panel frontal	X1	Soporta instalaciones en el panel frontal
	Conector de sonido frontal	X1	Soporta funciones de sonido en el panel frontal
	Conector de salida S/PDIF	X1	Soporta función de salida de sonido digital
	Cabecera de ventilador de CPU	X1	Fuente de alimentación de ventilador de CPU (con función Smart Fan)
	Cabecera de ventilador de sistema	X2	Fuente de alimentación de ventilador de sistema
	Cabecera de borrado de CMOS	X1	
	Conector USB	X2	Cada conector soporta 2 puertos USB frontales
	Conector de alimentación (24 patillas)	X1	
Conector de alimentación (4 patillas)	X1		
Panel trasero de E/S	Teclado PS/2	X1	
	Ratón PS/2	X1	
	Puerto serie	X1	
	Puerto de red local	X1	
	Puerto USB	X4	
	Conector de sonido	X3	
Tamaño de la placa	182 mm. (A) X 305 mm. (H)	ATX	
Soporte de sistema operativo	Windows XP / Vista / 7		Biostar se reserva el derecho de añadir o retirar el soporte de cualquier SO con o sin aviso previo.

PORTUGUESE

ESPECIFICAÇÕES		
CPU	Socket AM3 Processadores AMD Sempron / Athlon II / Phenom II (Watt máximo: 95W)	A arquitetura AMD 64 permite uma computação de 32 e 64 bits Suporta as tecnologias Hyper Transport 3.0
FSB	Suporta a tecnologia HyperTransport 3.0 com uma largura de banda até 5.2 GT/s	
Chipset	AMD 770 AMD SB710	
Especificação do Super I/O	ITE 8721 Proporciona as funcionalidades mais utilizadas em termos da especificação Super I/O. Interface LPC (Low Pin Count).	Iniciativas para controlo do ambiente Monitorização do hardware Controlador da velocidade da ventoinha Função "Smart Guardian" da ITE
Memória principal	Ranuras DIMM DDR3 x 2 Capacidade máxima de memória: 8GB Cada módulo DIMM suporta uma memória DDR3 de 512MB/ 1GB/2GB/4GB	Módulo de memória DDR3 de canal duplo Suporta módulos DDR3 800 / 1066 / 1333 Suporta módulos DDR3 1600 (OC) Os módulos DIMM registados e os DIMM ECC não são suportados
IDE	Controlador IDE integrado	Modo Bus master Ultra DMA 33 / 66 / 100 / 133 Suporta o modo PIO 0~4,
SATA II	Controlador Serial ATA integrado	Velocidades de transmissão de dados até 3 Gb/s. Compatibilidade com a especificação SATA versão 2.0. Suporta as funções RAID 0,1,10
LAN	Realtek RTL 8102EL	Auto negociação de 10 / 100 Mb/s Capacidade semi/full-duplex
Codec de som	ALC662 / VT1708B	Saída de áudio de 5.1 canais Suporta a especificação High-Definition Audio
Ranuras	Ranhura PCI x3 Ranhura PCI Express Gen2 x16 x1 Ranhura PCI Express Gen2 x1 x1	

ESPECIFICAÇÕES			
Conectores na placa	Conector da unidade de disquetes	x1	Cada conector suporta 1 unidade de disquete
	Conector da para impressora	x1	Cada conector suporta 1 Porta para impressora
	Conector IDE	x1	Cada conector suporta 2 dispositivos IDE
	Conector SATA	x4	Cada conector suporta 1 dispositivo SATA
	Conector do painel frontal	x1	Para suporte de várias funções no painel frontal
	Conector de áudio frontal	x1	Suporta a função de áudio no painel frontal
	Conector de saída S/PDIF	x1	Suporta a saída de áudio digital
	Conector da ventoinha da CPU	x1	Alimentação da ventoinha da CPU (com a função Smart Fan)
	Conector da ventoinha do sistema	x2	Alimentação da ventoinha do sistema
	Conector para limpeza do CMOS	x1	
	Conector USB	x2	Cada conector suporta 2 portas USB no painel frontal
	Conector de alimentação (24 pinos)	x1	
	Conector de alimentação (4 pinos)	x1	
Entradas/Saídas no painel traseiro	Teclado PS/2	x1	
	Rato PS/2	x1	
	Porta série	x1	
	Porta LAN	x1	
	Porta USB	x4	
	Tomada de áudio	x3	
Tamanho da placa	182 mm (L) X 305 mm (A)		ATX
Sistemas operativos suportados	Windows XP / Vista / 7		A Biostar reserva-se o direito de adicionar ou remover suporte para qualquer sistema operativo com ou sem aviso prévio.

POLISH

<i>SPEC</i>		
Procesor	Socket AM3 AMD Sempron / Athlon II / Phenom II Procesory (Maksymalny Watt: 95W)	Architektura AMD 64 umożliwia przetwarzanie 32 i 64 bitowe Obsługa Hyper Transport 3.0
FSB	Obsługa HyperTransport 3.0 o szerokości pasma do 5.2 GT/s	
Chipset	AMD 770 AMD SB710	
Pamięć główna	Gniazda DDR3 DIMM x 2 Maks. wielkość pamięci 8GB Każde gniazdo DIMM obsługuje moduły 512MB/1GB/2GB/4GB DDR3	Moduł pamięci DDR3 z trybem podwójnego kanału Obsługa DDR3 800 / 1066 / 1333 Obsługa DDR3 1600 (OC) Brak obsługi Registered DIMM oraz ECC DIMM
Super I/O	ITE 8721 Zapewnia najbardziej powszechne funkcje Super I/O. Interfejs Low Pin Count	Funkcje kontroli warunków pracy, Monitor H/W Kontroler prędkości wentylatora Funkcja ITE "Smart Guardian"
IDE	Zintegrowany kontroler IDE	Ultra DMA 33 / 66 / 100 / 133 Tryb Bus Master obsługa PIO tryb 0~4,
SATA II	Zintegrowany kontroler Serial ATA	Transfer danych do 3 Gb/s. Zgodność ze specyfikacją SATA w wersji 2.0. Obsługa RAID 0,1,10
LAN	Realtek RTL 8102EL	10 / 100 Mb/s z automatyczną negocjacją szybkości Działanie w trybie półowicznego/pełnego dupleksu
Kodek dźwiękowy	ALC662 / VT1708B	5.1 kanałowe wyjście audio Obsługa High-Definition Audio
Gniazda	Gniazdo PCI x3 Gniazdo PCI Express Gen2 x16 x1 Gniazdo PCI Express Gen2 x1 x1	

SPEC			
Złącza wbudowane	Złącze napędu dyskietek	x1	Każde złącze obsługuje 1 napędy dyskietek
	Złącze Port drukarki	x1	Każde złącze obsługuje 1 Port drukarki
	Złącze IDE	x1	Każde złącze obsługuje 2 urządzenia IDE
	Złącze SATA	x4	Każde złącze obsługuje 1 urządzenie SATA
	Złącze panela przedniego	x1	Obsługa elementów panela przedniego
	Przednie złącze audio	x1	Obsługa funkcji audio na panelu przednim
	Złącze wyjścia S/PDIF	x1	Obsługa funkcji cyfrowego wyjścia audio
	Złącze główkowe wentylatora procesora	x1	Zasilanie wentylatora procesora (z funkcją Smart Fan)
	Złącze główkowe wentylatora systemowego	x2	Zasilanie wentylatora systemowego
	Złącze główkowe kasowania CMOS	x1	
Back Panel I/O	Złącze USB	x2	Każde złącze obsługuje 2 porty USB na panelu przednim
	Złącze zasilania (24 pinowe)	x1	
	Złącze zasilania (4 pinowe)	x1	
	Klawiatura PS/2	x1	
	Mysz PS/2	x1	
	Port szeregowy	x1	
Wymiary płyty	Port LAN	x1	
	Port USB	x4	
Obsługa systemu operacyjnego	Gniazdo audio	x3	
	182 mm (S) X 305 mm (W)		ATX
	Windows XP / Vista / 7		Biostar zastrzega sobie prawo dodawania lub odwoływania obsługi dowolnego systemu operacyjnego bez powiadomienia.

RUSSIAN

СПЕЦ		
CPU (центральный процессор)	Гнездо AM3	Архитектура AMD 64 разрешать обработка
	Процессоры AMD Sempron / Athlon II /	данных на 32 и 64 бит
	Phenom II (Максимальный ватт: 95W)	Поддержка Hyper Transport 3.0
FSB	Поддержка HyperTransport 3.0 с пропускной способностью до 5.2 GT/s	
Набор микросхем	AMD 770 AMD SB710	
Основная память	Слоты DDR3 DIMM x 2 Максимальная ёмкость памяти 8ГБ Каждый модуль DIMM поддерживает 512МБ/1ГБ/2ГБ/4ГБ DDR3	Модуль памяти с двухканальным режимом DDR3 Поддержка DDR3 800 / 1066 / 1333 Поддержка DDR3 1600 (OC) Не поддерживает зарегистрированные модули DIMM and ECC DIMM
Super I/O	ITE 8721 Обеспечивает наиболее используемые действующие функциональные возможности Super I/O. Интерфейс с низким количеством выводов	Инициативы по охране окружающей среды, Аппаратный монитор Регулятор скорости Функция ITE "Smart Guardian" (Интеллектуальная защита)
IDE	Встроенное устройство управления встроенными интерфейсами устройств	Режим "хозяина" шины Ultra DMA 33 / 66 / 100 / 133 Поддержка режима PIO 0~4,
SATA II	Встроенное устройство управления встроенными интерфейсами устройств	скорость передачи данных до 3 гигабит/с. Соответствие спецификации SATA версия 2.0. Поддержка RAID 0,1,10
Локальная сеть	Realtek RTL 8102EL	Автоматическое согласование 10 / 100 Мб/с Частичная / полная дуплексная способность
Звуковой кодек	ALC662 / VT1708B	Звуковая поддержка High-Definition 5.1канальный звуковой выход
Слоты	Слот PCI	x3
	Слот PCI Express Gen2 x16	x1
	Слот PCI Express Gen2 x1	x1

СПЕЦ			
Встроенны й разъём	Разъём НГМД	x1	Каждый разъём поддерживает 1 накопителя на гибких магнитных дисках
	Разъём Порт подключения принтера	x1	Каждый разъём поддерживает 1 Порт подключения принтера
	Разъём IDE	x1	Каждый разъём поддерживает 2 встроенных интерфейса накопителей
	Разъём SATA	x4	Каждый разъём поддерживает 1 устройство SATA
	Разъём на лицевой панели	x1	Поддержка устройств на лицевой панели
	Входной звуковой разъём	x1	Поддержка звуковых функций на лицевой панели
	Разъём вывода для S/PDIF	x1	Поддержка вывода цифровой звуковой функции
	Контактирующее приспособление вентилятора центрального процессора	x1	Источник питания для вентилятора центрального процессора (с функцией интеллектуального вентилятора)
	Контактирующее приспособление вентилятора системы	x2	Источник питания для вентилятора системы
	Открытое контактирующее приспособление CMOS	x1	
	USB-разъём	x2	Каждый разъём поддерживает 2 USB-порта на лицевой панели
Разъем питания (24 вывод)	x1		
Разъем питания (4 вывод)	x1		
Задняя панель средств ввода-вывода	Клавиатура PS/2	x1	
	Мышь PS/2	x1	
	Последовательный порт	x1	
	Порт LAN	x1	
	USB-порт	x4	
	Гнездо для подключения наушников	x3	
Размер панели	182 мм (Ш) X 305 мм (В)		ATX
Поддержка OS	Windows XP / Vista / 7		Biostar сохраняет за собой право добавлять или удалять средства обеспечения для OS с или без предварительного уведомления.

ARABIC

المواصفات		
وحدة المعالجة المركزية	AM3 بمقياس AMD Sempron / Athlon II / Phenom II (95: قصوى واط)	إجراء العمليات الحاسوبية بسرعة 32 و 64 بت AMD 64 يمكن تقنية و Hyper Transport 3.0 تدعم تقنية
الثقل الأمامي الجانبي	5.2 GT/s يتردد يصل إلى HyperTransport 3.0 تدعم تقنية	
مجموعة الشرائح	AMD 770 AMD SB710	
الذاكرة الرئيسية	قناة DDR3 DIMM سعة ذاكرة قصوى 8 جيجا بايت ميغا بايت 512/سعة DDR3 تدعم ذاكرة من نوع DIMM تدعم كل قناة و 1/2 و 4 جيجا بايت	عدد 2 مزدوجة القناة DDR3 وحدة ذاكرة سعات 1333 / 1066 / 800 ميغا بايت DDR3 تدعم الذاكرة من نوع سعات 1600 ميغا بايت DDR3 (OC) تدعم الذاكرة من نوع ECC وتلك التي لا تتوافق مع DIMM لا تدعم رفائق الذاكرة
Super I/O	ITE 8721 الأكثر استخداماً. Super I/O يوفر وظيفة Low Pin Court Interface تدعم تقنية	وسائل التحكم في البيئة: مراقب لمعرفة حالة الأجهزة مراقب في سرعة المروحة ITE من "Smart Guardian" ووظيفة
منفذ IDE	متكامل IDE متحكم	Ultra DMA 33 / 66 / 100 / 133 نقل تقنية وضع رئيسي PIO Mode 0~4 دعم وضع
SATA II	متحكم Serial ATA متكامل	نقل البيانات بسرعة تصل إلى 3 جيجابت/ثانية. 2.0 الإصدار SATA مطابقة لمواصفات RAID 0,1,10 تدعم تقنية
شبكة داخلية	Realtek RTL 8102EL	تفاوض تلقائي 100/10 ميغا بايت / ثانية إمكانية النقل المزدوج الكامل/الصففي
كوديك الصوت	ALC662 / VT1708B	تدعم تقنية الصوت عالي التعريف من 5.1 قنوات لخرج الصوت
الفتحات	قناة PCI قناة PCI Express Gen2 x 16 قناة PCI Express Gen2 x 1	عدد 3 عدد 1 عدد 1

المواصفات		
يدعم محرك الأقراص المرنة	عدد 1	منفذ محرك أقراص مرنة
	عدد 1	منفذ طباعة
يدعم كل منفذ اثنين من أجهزة IDE	عدد 1	منفذ IDE
يدعم كل منفذ واحد من أجهزة SATA	عدد 4	منفذ SATA
يدعم تجهيزات اللوحة الأمامية	عدد 1	منفذ اللوحة الأمامية
يدعم وظيفة الصوت باللوحة الأمامية	عدد 1	منفذ الصوت الأمامي
يدعم وظيفة خرج الصوت الرقمي	عدد 1	منفذ خرج S/PDIF
Smart Fan لتوصيل الطاقة لمروحة وحدة المعالجة مع وظيفة	عدد 1	وصلة مروحة وحدة المعالجة المركزية
لتوصيل الطاقة لمروحة النظام	عدد 2	وصلة مروحة النظام
	عدد 1	وصلة مسح CMOS
باللوحة الأمامية USB يدعم كل منفذ قحطي	عدد 2	منفذ USB
	عدد 1	منفذ توصيل الطاقة (24 دبوس)
	عدد 12	منفذ توصيل الطاقة (4 دبوس)
	عدد 1	لوحة مفاتيح PS/2
	عدد 1	ملوس PS/2
	عدد 1	منفذ تسلسلي
	عدد 1	منفذ شبكة اتصال محلية
	عدد 4	منافذ USB
	عدد 3	مقيس صوت
ATX	182 مم (عرض) X 305 مم (الارتفاع)	حجم اللوحة
بحقها في اإضافة أو إزالة الدعم لأي نظام تشغيل بإخطار أو Biostar تحتفظ بدون إخطار .	Windows XP / Vista / 7	دعم أنظمة التشغيل

JAPANESE

仕様		
CPU	Socket AM3 AMD Sempron / Athlon II / Phenom II プロセッサ (最高のワット: 95W)	AMD 64アーキテクチャでは、32ビットと64ビット計算が可能です ハイパートランスポート3.0をサポートします
FSB	5.2 GT/sのバンド幅までハイパートランスポート3.0をサポートします	
チップセット	AMD 770 AMD SB710	
メインメモリ	DDR3 DIMMスロット x 2 最大メモリ容量8GB 各DIMMは 512MB/1GB/2GB/4GB DDR3をサポート	デュアル チャンネルモードDDR3 メモリモジュール DDR3 800 / 1066 / 1333 をサポート DDR3 1600 をサポート (OC) 登録済みDIMMとECC DIMMはサポートされません
Super I/O	ITE 8721 もっとも一般に使用されるレガシーSuper I/O機能を採用しています。 低ピンカウントインターフェイス	環境コントロールイニシアチブ、 H/Wモニター ファン速度コントローラ/ モニター ITEの「スマートガーディアン」機能
IDE	統合IDEコントローラ	Ultra DMA 33 / 66 / 100 / 133バスマスタモード PIO Mode 0~4のサポート、
SATA II	統合Serial ATAコントローラ	最高3 Gb/秒のデータ転送速度 SATAバージョン2.0仕様準拠。 RAID 0,1,10のサポート
LAN	Realtek RTL 8102EL	10 / 100 / 1000 Mb/秒のオートネゴシエーション 半/全二重機能
サウンド Codec	ALC662 / VT1708B	ハイデフィニションオーディオのサポート 5.1 チャンネルオーディオアウト
スロット	PCIスロット x3 PCI Express Gen2 x16スロット x1 PCI Express Gen2 x1スロット x1	

仕様			
オンボードコネクタ	フロッピーコネクタ	x1	各コネクタは1つのフロッピードライブをサポートします
	プリンタポートコネクタ	x1	各コネクタは1つのプリンタポートをサポートします
	IDEコネクタ	x1	各コネクタは2つのIDEデバイスをサポートします
	SATAコネクタ	x4	各コネクタは1つのSATAデバイスをサポートします
	フロントパネルコネクタ	x1	フロントパネル機能をサポートします
	フロントオーディオコネクタ	x1	フロントパネルオーディオ機能をサポートします
	S/PDIFアウトコネクタ	x1	デジタルオーディオアウト機能をサポートします
	CPUファンヘッダ	x1	CPUファン電源装置(スマートファン機能を搭載)
	システムファンヘッダ	x2	システムファン電源装置
	CMOSクリアヘッダ	x1	
オンボードコネクタ	USBコネクタ	x2	各コネクタは2つのフロントパネルUSBポートをサポートします
	電源コネクタ(24ピン)	x1	
	電源コネクタ(4ピン)	x1	
背面パネルI/O	PS/2キーボード	x1	
	PS/2マウス	x1	
	シリアルポート	x1	
	LANポート	x1	
	USBポート	x4	
	オーディオジャック	x3	
ボードサイズ	182 mm (幅) X 305 mm (高さ)	ATX	
OSサポート	Windows XP / Vista / 7		Biostarは事前のサポートなしにOSサポートを追加または削除する権利を留保します。

2010/02/05