

## **FCC Information and Copyright**

This equipment has been tested and found to comply with the limits of a Class B digital device, pursuant to Part 15 of the FCC Rules. These limits are designed to provide reasonable protection against harmful interference in a residential installation. This equipment generates, uses, and can radiate radio frequency energy and, if not installed and used in accordance with the instructions, may cause harmful interference to radio communications. There is no guarantee that interference will not occur in a particular installation.

The vendor makes no representations or warranties with respect to the contents here and specially disclaims any implied warranties of merchantability or fitness for any purpose. Further the vendor reserves the right to revise this publication and to make changes to the contents here without obligation to notify any party beforehand.

Duplication of this publication, in part or in whole, is not allowed without first obtaining the vendor's approval in writing.

The content of this user's manual is subject to be changed without notice and we will not be responsible for any mistakes found in this user's manual. All the brand and product names are trademarks of their respective companies.

---

---

## Table of Contents

---

---

<b>Chapter 1: Introduction</b> .....	<b>1</b>
<b>1.1 Before You Start</b> .....	1
<b>1.2 Package Checklist</b> .....	1
<b>1.3 Motherboard Features</b> .....	2
<b>1.4 Rear Panel Connectors</b> .....	3
<b>1.5 Motherboard Layout</b> .....	4
<b>Chapter 2: Hardware Installation</b> .....	<b>5</b>
<b>2.1 Installing Central Processing Unit (CPU)</b> .....	5
<b>2.2 FAN Headers</b> .....	7
<b>2.3 Installing System Memory</b> .....	8
<b>2.4 Connectors and Slots</b> .....	10
<b>Chapter 3: Headers &amp; Jumpers Setup</b> .....	<b>13</b>
<b>3.1 How to Setup Jumpers</b> .....	13
<b>3.2 Detail Settings</b> .....	13
<b>Chapter 4: Hybrid CrossFireX Function</b> .....	<b>19</b>
<b>4.1 Hybrid CrossFireX Requirements</b> .....	19
<b>4.2 Hybrid CrossFireX Installation</b> .....	19
<b>Chapter 5: RAID Functions</b> .....	<b>20</b>
<b>5.1 Operating System</b> .....	20
<b>5.2 Raid Arrays</b> .....	20
<b>5.3 How RAID Works</b> .....	20
<b>Chapter 6: T-Series BIOS &amp; Software</b> .....	<b>23</b>
<b>6.1 T-Series BIOS</b> .....	23
<b>6.2 T-Series Software</b> .....	31
<b>Chapter 7: Useful Help</b> .....	<b>41</b>
<b>7.1 Driver Installation Note</b> .....	41
<b>7.2 Extra Information</b> .....	42
<b>7.3 AMI BIOS Beep Code</b> .....	43
<b>7.4 Troubleshooting</b> .....	44
<b>Appendix: SPEC In Other Languages</b> .....	<b>46</b>
<b>German</b> .....	46
<b>French</b> .....	48
<b>Italian</b> .....	50
<b>Spanish</b> .....	52
<b>Portuguese</b> .....	54
<b>Polish</b> .....	56
<b>Russian</b> .....	58
<b>Arabic</b> .....	60
<b>Japanese</b> .....	62

---

---

## **CHAPTER 1: INTRODUCTION**

### **1.1 BEFORE YOU START**

Thank you for choosing our product. Before you start installing the motherboard, please make sure you follow the instructions below:

- Prepare a dry and stable working environment with sufficient lighting.
- Always disconnect the computer from power outlet before operation.
- Before you take the motherboard out from anti-static bag, ground yourself properly by touching any safely grounded appliance, or use grounded wrist strap to remove the static charge.
- Avoid touching the components on motherboard or the rear side of the board unless necessary. Hold the board on the edge, do not try to bend or flex the board.
- Do not leave any unfastened small parts inside the case after installation. Loose parts will cause short circuits which may damage the equipment.
- Keep the computer from dangerous area, such as heat source, humid air and water.
- The operating temperatures of the computer should be 0 to 45 degrees Celsius.

### **1.2 PACKAGE CHECKLIST**

- ✚ IDE Cable X 1 (optional)
- ✚ Serial ATA Cable X 3
- ✚ Serial ATA Power Cable X 1
- ✚ Rear I/O Panel for ATX Case X 1
- ✚ User's Manual X 1
- ✚ Fully Setup Driver CD X 1
- ✚ FDD Cable X 1 (optional)
- ✚ USB 2.0 Cable X1 (optional)
- ✚ S/PDIF out Cable X 1 (optional)

**Note:** The package contents may be different due to area or your motherboard version.

### 1.3 MOTHERBOARD FEATURES

SPEC			
CPU	Socket AM3 AMD Sempron / Phenom II / Athlon II processors		AMD 64 Architecture enables 32 and 64 bit computing Supports Hyper Transport 3.0
FSB	Support HyperTransport 3.0 Supports up to 5.2 GT/s Bandwidth		
Chipset	AMD 880G AMD SB710		
Super I/O	ITE 8721 Provides the most commonly used legacy Super I/O functionality. Low Pin Count Interface		Environment Control initiatives, H/W Monitor Fan Speed Controller ITE's "Smart Guardian" function
Main Memory	DDR3 DIMM Slots x 4 Max Memory Capacity 16GB Each DIMM supports 512MB/ 1GB/2GB/4GB DDR3		Dual Channel Mode DDR3 memory module Supports DDR3 800 / 1066 / 1333 Supports DDR3 1600 (OC)
Graphics	AMD 880G (Radeon HD4250)		Max Shared Video Memory is 512MB DVI/HDMI/UVD/HDCP support
SATA 2	Integrated Serial ATA Controller		Data transfer rates up to 3 Gb/s. SATA Version 2.0 specification compliant. RAID 0,1,10 support
LAN	Realtek RTL8111E		10 / 100 Mb/s / 1Gb/s auto negotiation Half / Full duplex capability
Sound	ALC892		5.1channels audio out Supports HD Audio
Slots	PCI Slot	x2	Supports PCI expansion cards
	PCI Express Gen2 x16 Slot	x1	Supports PCI-E Gen2 x16 expansion card
On Board Connectors	SATA Connector	x6	Each connector supports 1 SATA device
	Front Panel Connector	x1	Supports front panel facilities
	Front Audio Connector	x1	Supports front panel audio function
	S/PDIF out Connector	x1	Supports digital audio out function
	CPU Fan Header	x1	CPU Fan power supply (with Smart Fan function)
	System Fan Header	x2	System Fan Power supply
	CMOS clear Header	x1	Restore CMOS data to factory default

SPEC			
	USB Connector	x3	Each connector supports 2 front panel USB ports
	Printer Port Connector	x1	Each connector supports 1 Printer port
	Serial Port Connector	x1	Connects to RS-232 Port
	Consumer IR Connector	x1	Supports infrared function
	Power Connector (24pin)	x1	Connects to Power supply
	Power Connector (4pin)	x1	Connects to Power supply
Back Panel I/O	PS/2 Keyboard / Mouse	x1	Connects to PS/2 Keyboard / Mouse
	HDMI Port	x1	Connects to HDMI cable
	VGA Port	x1	Connect to D-SUB monitor
	DVI-D Port	x1	Connect to DVI monitor
	LAN Port	x1	Connect to RJ-45 ethernet cable
	USB Port	x4	Connect to USB devices
	Audio Jack	x3	Provide Audio-In/Out and microphone connection
Board Size	233 mm (W) x 244 mm (L)		uATX
OS Support	Windows XP / Vista / 7		Biostar reserves the right to add or remove support for any OS With or without notice.

## 1.4 REAR PANEL CONNECTORS

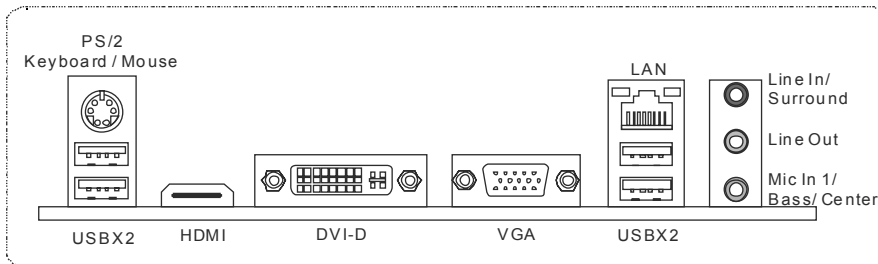

**NOTE:** The HDMI and DVI-D ports both can provide digital video signals out-put function, but these two interfaces cannot work at the same time. The chipset uses the same channel to control HDMI and DVI-D, so these ports cannot transmit video signal to different display panels simultaneously.

## 1.5 MOTHERBOARD LAYOUT

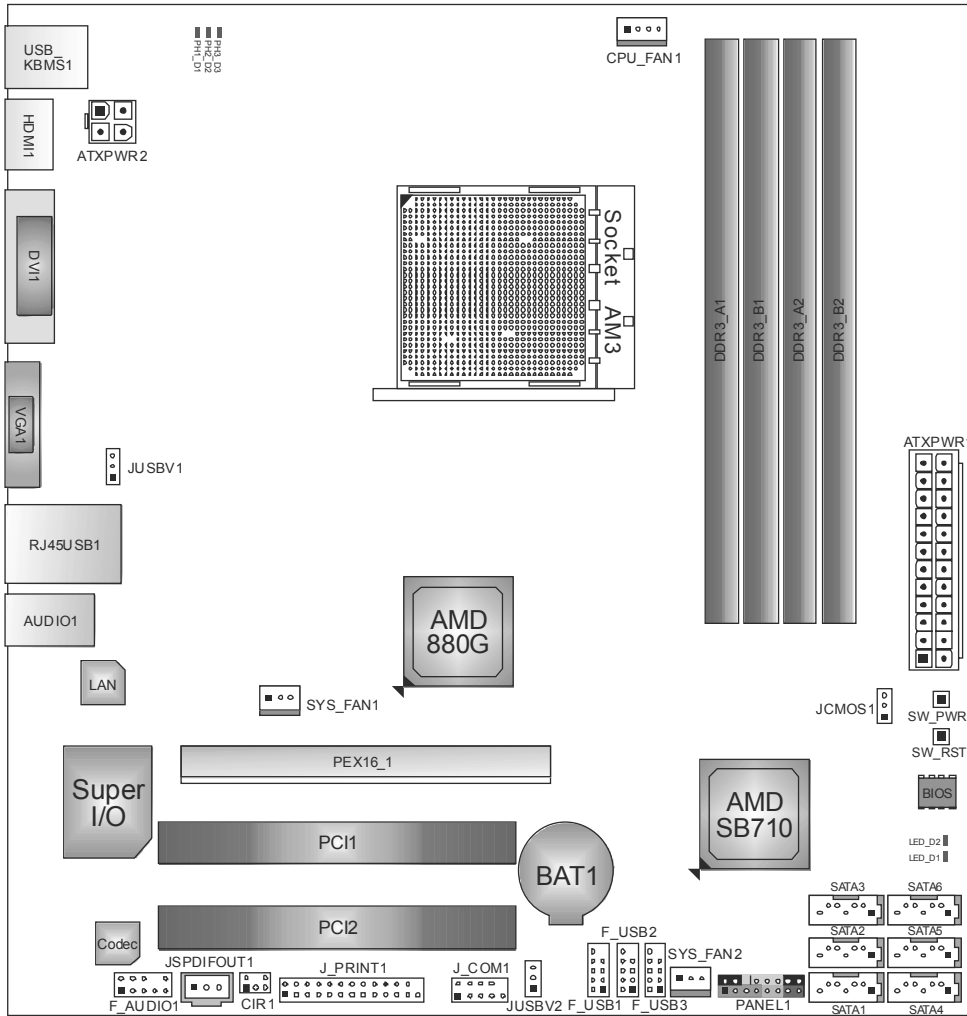

**Note:** ■ represents the 1<sup>st</sup> pin.

## CHAPTER 2: HARDWARE INSTALLATION

### 2.1 INSTALLING CENTRAL PROCESSING UNIT (CPU)

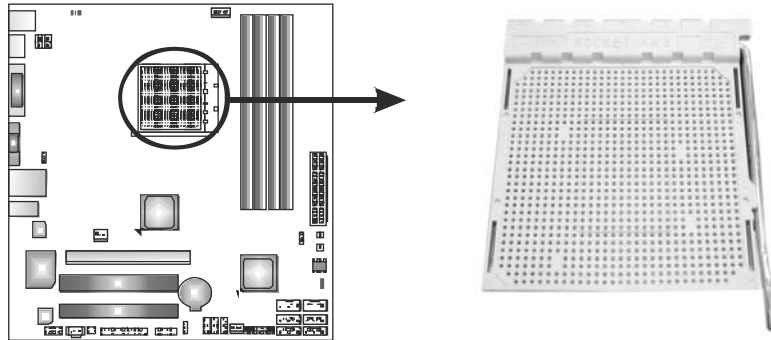

**Step 1:** Pull the lever toward direction A from the socket and then raise the lever up to a 90-degree angle.

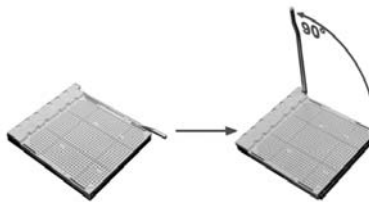

**Step 2:** Look for the white triangle on socket, and the gold triangle on CPU should point towards this white triangle. The CPU will fit only in the correct orientation.



**Step 3:** Hold the CPU down firmly, and then close the lever toward direct B to complete the installation.

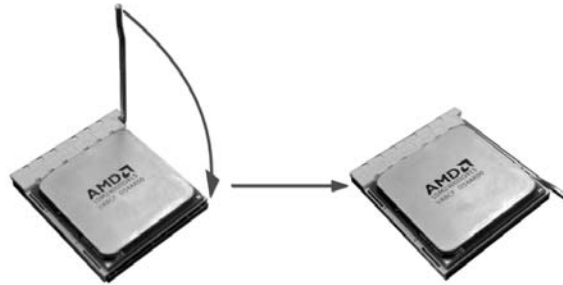

**Step 4:** Put the CPU Fan on the CPU and buckle it. Connect the CPU FAN power cable to the CPU\_FAN1. This completes the installation.



## 2.2 FAN HEADERS

These fan headers support cooling-fans built in the computer. The fan cable and connector may be different according to the fan manufacturer. Connect the fan cable to the connector while matching the black wire to pin#1.

### CPU\_FAN1: CPU Fan Header

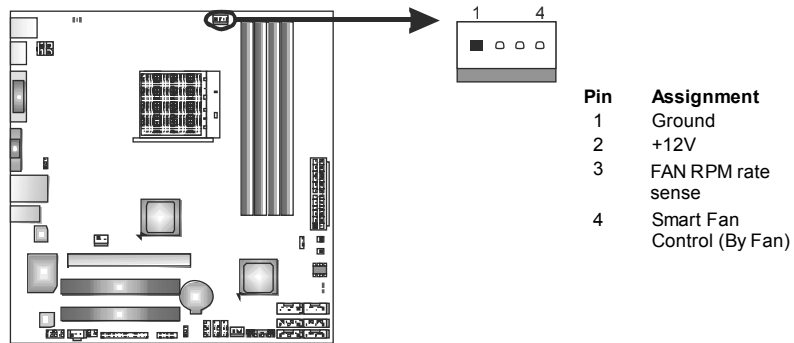

### SYS\_FAN1: NorthBridge Fan Header

### SYS\_FAN2: System Fan Header

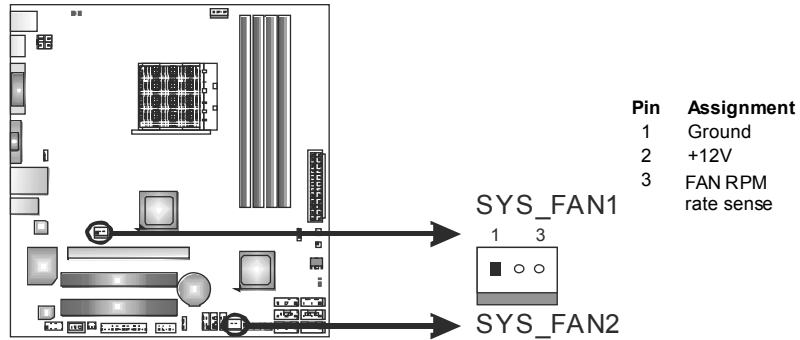

**Note:**

CPU\_FAN1, SYS\_FAN1/2 support 4-pin and 3-pin head connectors. When connecting with wires onto connectors, please note that the red wire is the positive and should be connected to pin#2, and the black wire is Ground and should be connected to GND.

## 2.3 INSTALLING SYSTEM MEMORY

### A. DDR3 Modules

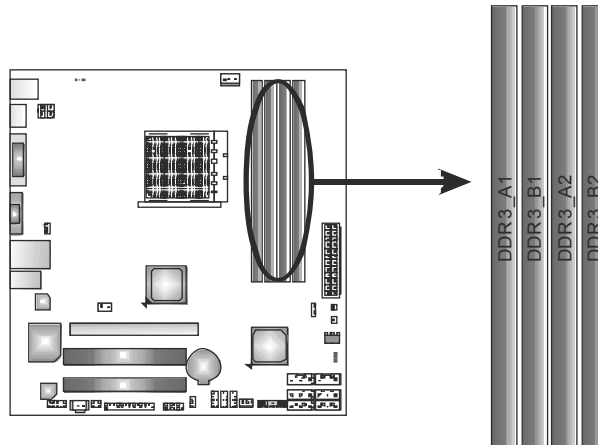

1. Unlock a DIMM slot by pressing the retaining clips outward. Align a DIMM on the slot such that the notch on the DIMM matches the break on the Slot.

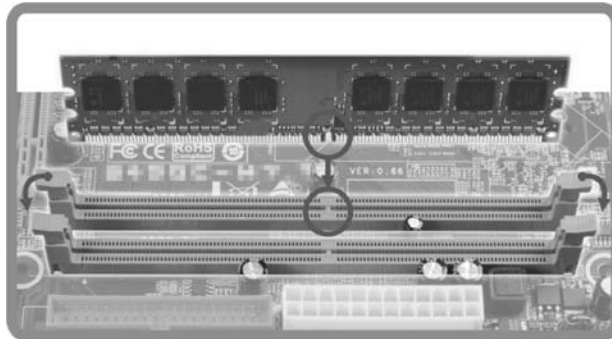

2. Insert the DIMM vertically and firmly into the slot until the retaining chip snap back in place and the DIMM is properly seated.

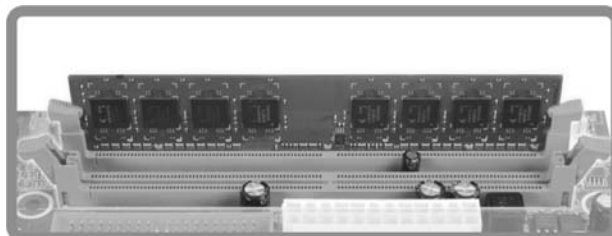

### ***B. Memory Capacity***

<b>DIMM Socket Location</b>	<b>DDR3 Module</b>	<b>Total Memory Size</b>
DDR3_A1	512MB/1GB/2GB/4GB	Max is 16GB.
DDR3_B1	512MB/1GB/2GB/4GB	
DDR3_A2	512MB/1GB/2GB/4GB	
DDR3_B2	512MB/1GB/2GB/4GB	

### ***C. Dual Channel Memory installation***

Please refer to the following requirements to activate Dual Channel function:

Install memory module of the same density in pairs, shown in the table.

<b>Dual Channel Status</b>	<b>DDR3_A1</b>	<b>DDR3_B1</b>	<b>DDR3_A2</b>	<b>DDR3_B2</b>
Enabled	O	O	X	X
Enabled	X	X	O	O
Enabled	O	O	O	O

(O means memory installed, X means memory not installed.)

The DRAM bus width of the memory module must be the same (x8 or x16)

## 2.4 CONNECTORS AND SLOTS

### SATA1~SATA6: Serial ATA Connectors

The motherboard has a PCI to SATA Controller with 6 channels SATA interface, it satisfies the SATA 2.0 spec and with transfer rate of 3.0Gb/s.

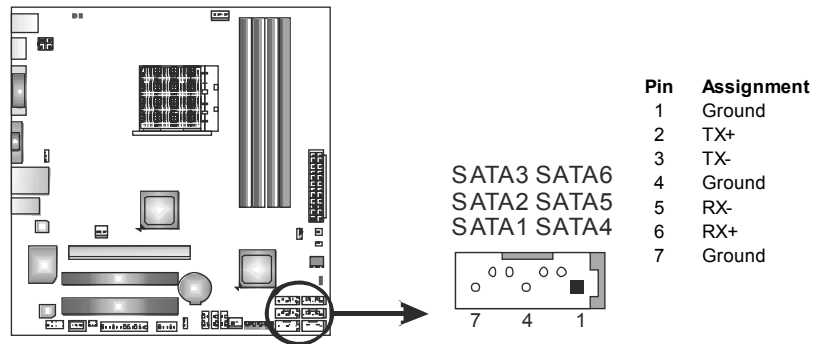

### ATXPWR2: ATX Power Source Connector

Connecting this connector will provide +12V to CPU power circuit.

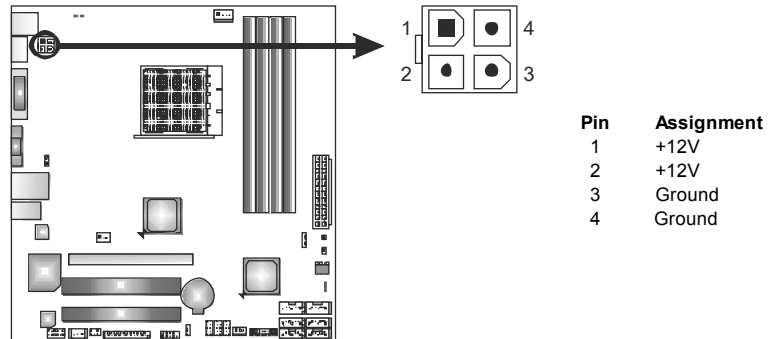

### ATXPWR1: ATX Power Source Connector

This connector allows user to connect 24-pin power connector on the ATX power supply.

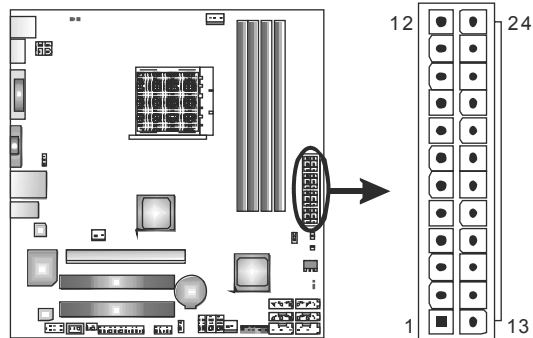

Pin	Assignment	Pin	Assignment
13	+3.3V	1	+3.3V
14	-12V	2	+3.3V
15	Ground	3	Ground
16	PS_ON	4	+5V
17	Ground	5	Ground
18	Ground	6	+5V
19	Ground	7	Ground
20	NC	8	PW_OK
21	+5V	9	Standby Voltage+5V
22	+5V	10	+12V
23	+5V	11	+12V
24	Ground	12	+3.3V

#### Note:

Before power on the system, please make sure that both ATXPWR1 and ATXPWR2 connectors have been plugged-in.

**PEX16\_1: PCI-Express Gen2 x16 Slot**

- PCI-Express 2.0 compliant.
- Maximum theoretical realized bandwidth of 8GB/s simultaneously per direction, for an aggregate of 16GB/s totally.
- PCI-Express Gen2 supports a raw bit-rate of 5.0Gb/s on the data pins.
- 2X bandwidth over the PCI-Express 1.1 architecture.

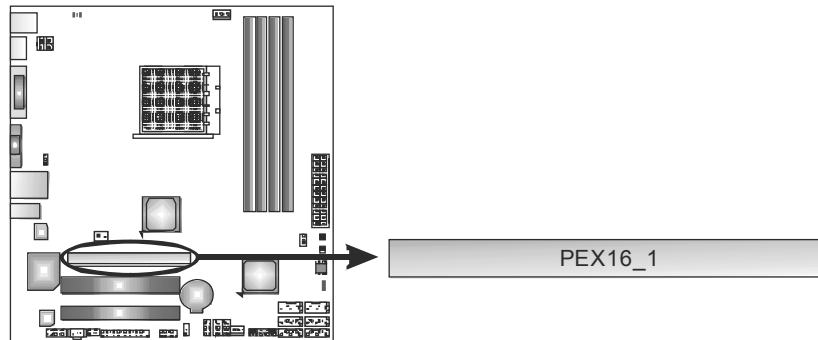

**PCI1/PCI2: Peripheral Component Interconnect Slots**

This motherboard is equipped with 2 standard PCI slots. PCI stands for Peripheral Component Interconnect, and it is a bus standard for expansion cards. This PCI slot is designated as 32 bits.

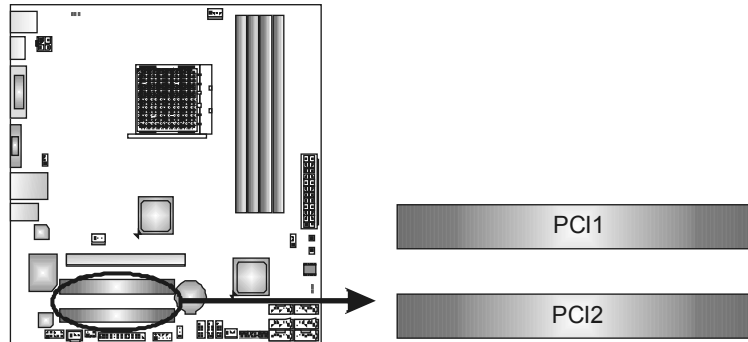

## CHAPTER 3: HEADERS & JUMPERS SETUP

### 3.1 HOW TO SETUP JUMPERS

The illustration shows how to set up jumpers. When the jumper cap is placed on pins, the jumper is “close”, if not, that means the jumper is “open”.



### 3.2 DETAIL SETTINGS

#### PANEL1: Front Panel Header

This 16-pin connector includes Power-on, Reset, HDD LED, Power LED, and speaker connection. It allows user to connect the PC case's front panel switch functions.

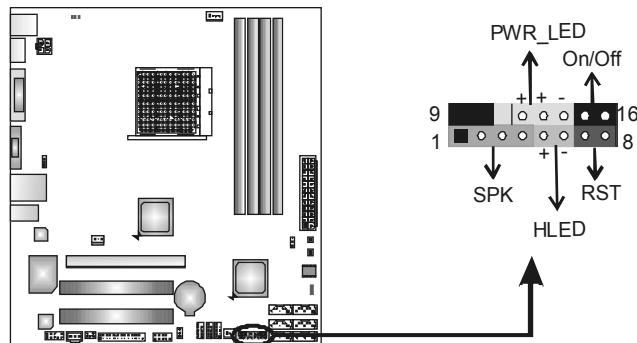

Pin	Assignment	Function	Pin	Assignment	Function
1	+5V	Speaker Connector	9	N/A	N/A
2	N/A		10	N/A	N/A
3	N/A		11	N/A	N/A
4	Speaker	Hard drive LED	12	Power LED (+)	Power LED
5	HDD LED (+)		13	Power LED (+)	
6	HDD LED (-)		14	Power LED (-)	
7	Ground	Reset button	15	Power button	Power-on button
8	Reset control		16	Ground	

### JCMOS1: Clear CMOS Header

Placing the jumper on pin2-3 allows user to restore the BIOS safe setting and the CMOS data. Please carefully follow the procedures to avoid damaging the motherboard.

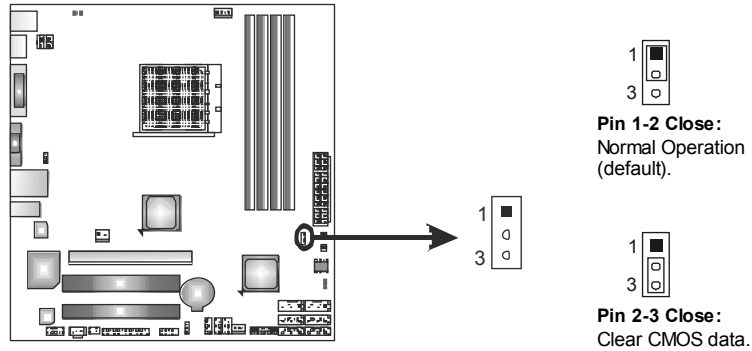

#### ※ Clear CMOS Procedures:

1. Remove AC power line.
2. Set the jumper to "Pin 2-3 close".
3. Wait for five seconds.
4. Set the jumper to "Pin 1-2 close".
5. Power on the AC.
6. Reset your desired password or clear the CMOS data.

### CIR1: Consumer IR Connector

This header is for infrared remote control and communication.

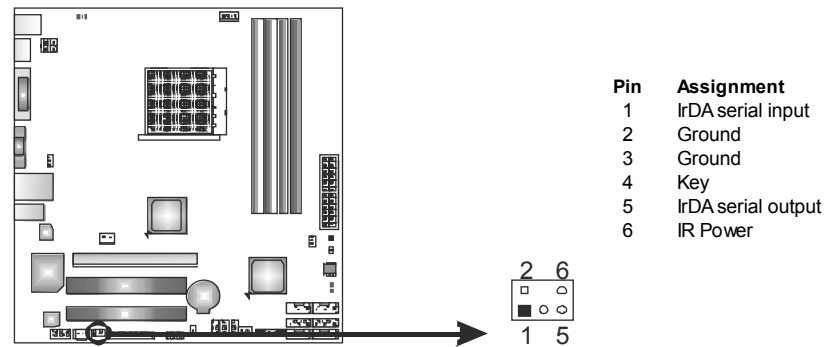



**F\_AUDIO1: Front Panel Audio Header**

This header allows user to connect the front audio output cable with the PC front panel. This header allows only HD audio front panel connector; AC'97 connector is not acceptable.

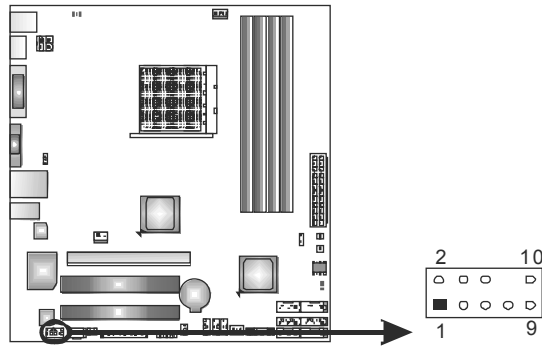

Pin	Assignment
1	Mic Left in
2	Ground
3	Mic Right in
4	GPIO
5	Right line in
6	Jack Sense
7	Front Sense
8	Key
9	Left line in
10	Jack Sense

**JSPDIFOUT1: Digital Audio-out Connector**

This connector allows user to connect the PCI bracket SPDIF output header.

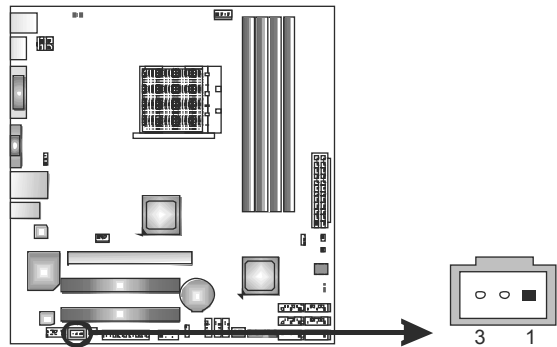

Pin	Assignment
1	+5V
2	SPDIF_OUT
3	Ground

### J\_PRINT1: Printer Port Connector

This header allows you to connector printer on the PC.

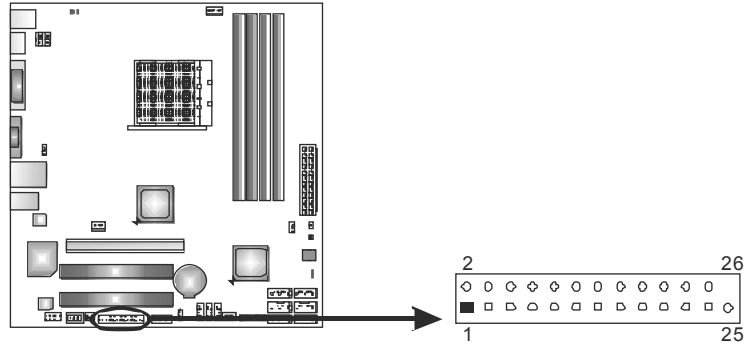

Pin	Assignment	Pin	Assignment
1	-Strobe	14	Ground
2	-ALF	15	Data 6
3	Data 0	16	Ground
4	-Error	17	Data 7
5	Data 1	18	Ground
6	-Init	19	-ACK
7	Data 2	20	Ground
8	-Scltin	21	Busy
9	Data 3	22	Ground
10	Ground	23	PE
11	Data 4	24	Ground
12	Ground	25	SCLT
13	Data 5	26	Key

### J\_COM1: Serial port Connector

The motherboard has a Serial Port Connector for connecting RS-232 Port.

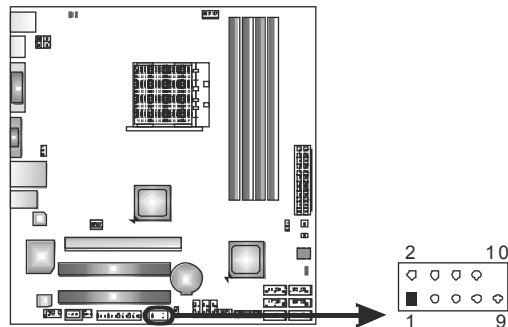

Pin	Assignment
1	Carrier detect
2	Received data
3	Transmitted data
4	Data terminal ready
5	Signal ground
6	Data set ready
7	Request to send
8	Clear to send
9	Ring indicator
10	NC

**F\_USB1~F\_USB3: Headers for USB 2.0 Ports at Front Panel**

These headers allow user to connect additional USB cable on the PC front panel, and also can be connected with internal USB devices, like USB card reader.

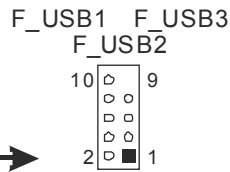
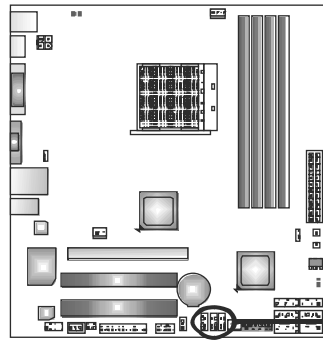

Pin	Assignment
1	+5V (fused)
2	+5V (fused)
3	USB-
4	USB-
5	USB+
6	USB+
7	Ground
8	Ground
9	Key
10	NC

**JUSBV1/JUSBV2: Power Source Headers for USB Ports**

*Pin 1-2 Close:*

JUSBV1: +5V for USB ports at USB\_KBMS1/RJ45USB1.

JUSBV2: +5V for USB ports at F\_USB1/F\_USB2/F\_USB3.

*Pin 2-3 Close:*

JUSBV1: +5V STB for USB ports at USB\_KBMS 1/RJ45USB1.

JUSBV2: +5V STB for USB ports at F\_USB1/F\_USB2/F\_USB3.

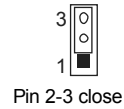
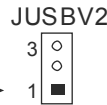
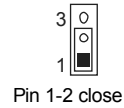
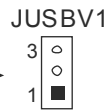
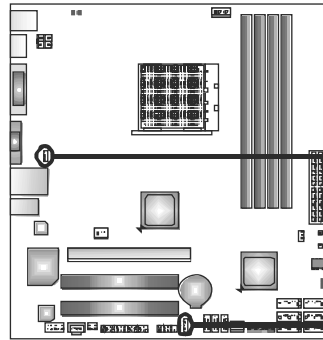

### On-Board LED Indicators

There are 5 LED indicators showing system status.

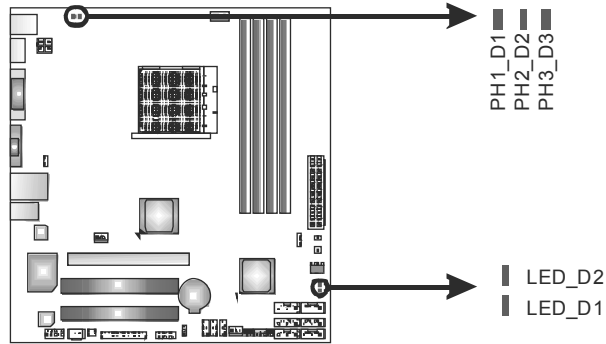

**LED\_D1 & LED\_D2:** Debug Indicators

**PH1\_D1 ~ PH3\_D3** Power Status Indicators

Please refer to the tables below for specific messages:

LED_D1	LED_D2	Message
ON	ON	Normal
ON	OFF	Memory Error
OFF	ON	VGA Error
OFF	OFF	Abnormal: CPU / Chipset error.

PH1_D1 ~ PH3_D3	Phase Indicator
ON	Phase Active
OFF	Phase Disable

### On-Board Buttons

There are 2 on-board buttons.

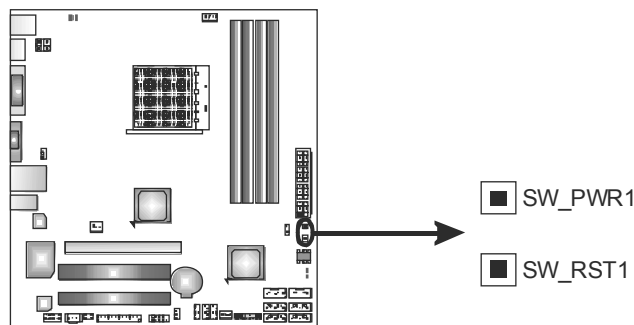

**SW\_RST1:** Reset button.

**SW\_PWR1:** Power Switch button.

## CHAPTER 4: HYBRID CROSSFIREX FUNCTION

### 4.1 HYBRID CROSSFIREX REQUIREMENTS

- A graphics card with **Hybrid technology**.
- The graphics card driver should support Hybrid CrossFireX technology.
- Operating System: Windows Vista and Windows 7.
- Memory Capacity: 1GB minimum.
- On-board graphics card RAM: 256MB
- The power supply unit must provide at least the minimum power required by the system, or the system will be unstable. A power supply above 450W is recommended under Hybrid CrossFireX mode.

#### NOTE

Please visit AMD/ATI website for the latest graphics card support list.

### 4.2 HYBRID CROSSFIREX INSTALLATION

**Step 1:** Insert the Hybrid CrossFireX-Ready graphics card into PEX16\_1.

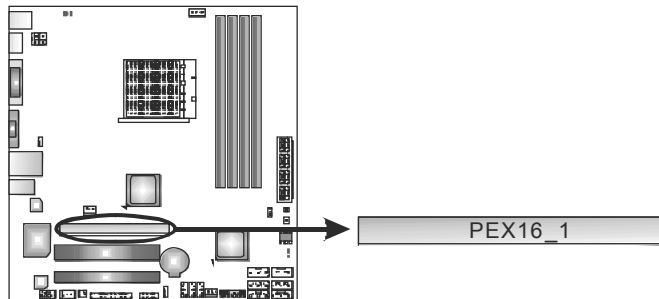

**Notice:** Make sure the graphics card is seated into slot completely.

**Step 2:** Configure BIOS setting: set **Surround View** from [Auto] to [Enabled].

**Step 3:** In the graphics card configuration program, choose "Hybrid CrossFireX" function. Installation completes.

## CHAPTER 5: RAID FUNCTIONS

### 5.1 OPERATING SYSTEM

Supports Windows Vista and Windows 7.

### 5.2 RAID ARRAYS

RAID supports the following types of RAID arrays:

**RAID 0:** RAID 0 defines a disk striping scheme that improves disk read and write times for many applications.

**RAID 1:** RAID 1 defines techniques for mirroring data.

**RAID 10:** RAID 10 combines the techniques used in RAID 0 and RAID 1.

### 5.3 How RAID WORKS

#### RAID 0:

The controller “stripes” data across multiple drives in a RAID 0 array system. It breaks up a large file into smaller blocks and performs disk reads and writes across multiple drives in parallel. The size of each block is determined by the stripe size parameter, which you set during the creation of the RAID set based on the system environment. This technique reduces overall disk access time and offers high bandwidth.

#### Features and Benefits

- **Drives:** Minimum 2, and maximum is up to 6 or 8. Depending on the platform.
- **Uses:** Intended for non-critical data requiring high data throughput, or any environment that does not require fault tolerance.
- **Benefits:** provides increased data throughput, especially for large files. No capacity loss penalty for parity.
- **Drawbacks:** Does not deliver any fault tolerance. If any drive in the array fails, all data is lost.
- **Fault Tolerance:** No.

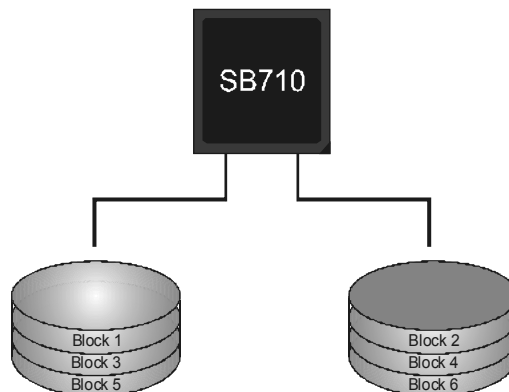

**RAID 1:**

Every read and write is actually carried out in parallel across 2 disk drives in a RAID 1 array system. The mirrored (backup) copy of the data can reside on the same disk or on a second redundant drive in the array. RAID 1 provides a hot-standby copy of data if the active volume or drive is corrupted or becomes unavailable because of a hardware failure. RAID techniques can be applied for high-availability solutions, or as a form of automatic backup that eliminates tedious manual backups to more expensive and less reliable media.

**Features and Benefits**

- **Drives:** Minimum 2, and maximum is 2.
- **Uses:** RAID 1 is ideal for small databases or any other application that requires fault tolerance and minimal capacity.
- **Benefits:** Provides 100% data redundancy. Should one drive fail, the controller switches to the other drive.
- **Drawbacks:** Requires 2 drives for the storage space of one drive. Performance is impaired during drive rebuilds.
- **Fault Tolerance:** Yes.

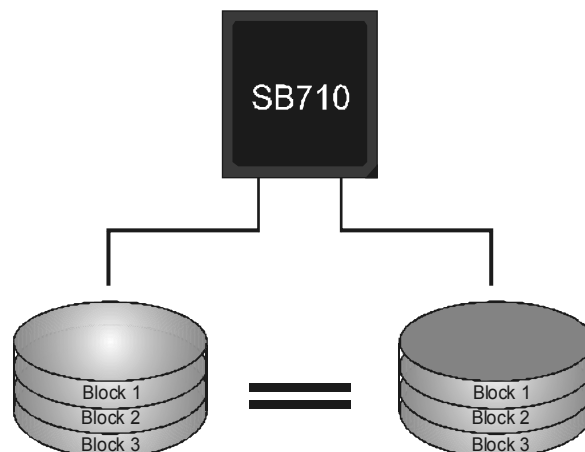

**RAID 10:**

RAID 1 drives can be striped using RAID 0 techniques. Resulting in a RAID 10 solution for improved resiliency, performance and rebuild performance.

**Features and Benefits**

- **Drives:** Minimum 4, and maximum is 6 or 8, depending on the platform.
- **Benefits:** Optimizes for both fault tolerance and performance, allowing for automatic redundancy. May be simultaneously used with other RAID levels in an array, and allows for spare disks.
- **Drawbacks:** Requires twice the available disk space for data redundancy, the same as RAID level 1.
- **Fault Tolerance:** Yes.

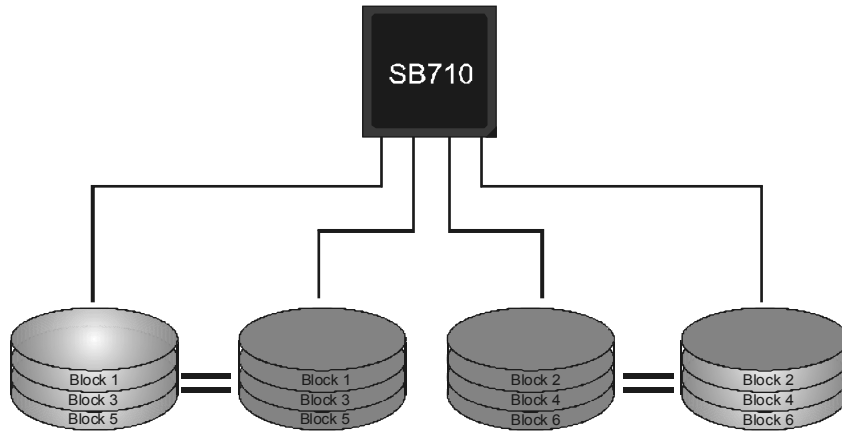



## CHAPTER 6: T-SERIES BIOS & SOFTWARE

### 6.1 T-SERIES BIOS

#### T-Series BIOS Features

- Overclocking Navigator Engine (O.N.E.)
- Memory Integration Test (M.I.T., under Overclock Navigator Engine)
- BIO-Flasher: Update BIOS file from USB Flash Drive or FDD
- Self Recovery System (S.R.S)
- Smart Fan Function
- CMOS Reloading Program

#### !! WARNING !!

For better system performance, the BIOS firmware is being continuously updated. The BIOS information described below in this manual is for your reference only and the actual BIOS information and settings on board may be different from this manual. For further information of setting up the BIOS, please refer to the BIOS Manual in the Setup CD.

#### A. Overclocking Navigator Engine (O.N.E.)

ONE provides two powerful overclocking engines: MOS and AOS for both Elite and Casual overclockers.

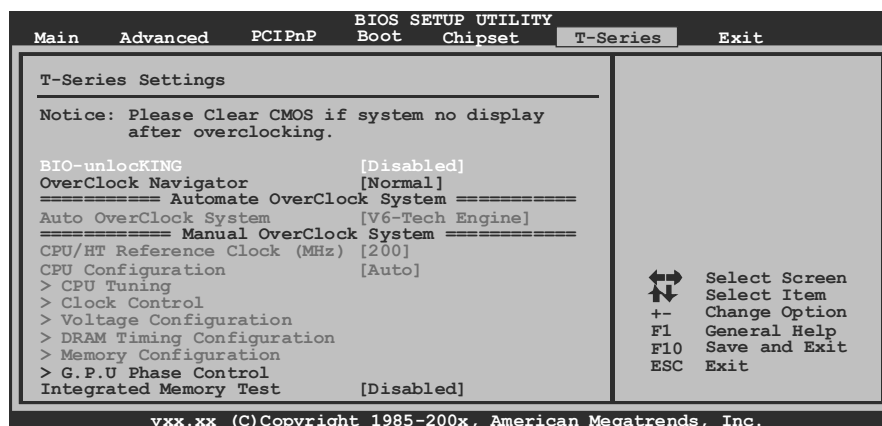

## Manual Overclock System (M.O.S.)

MOS is designed for experienced overclock users. It allows users to customize personal overclock settings.

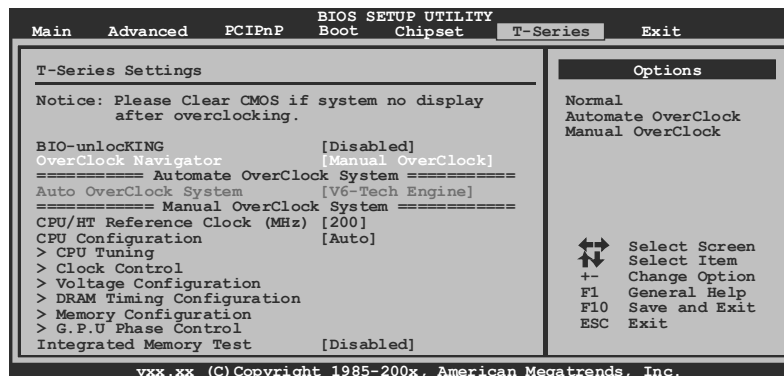
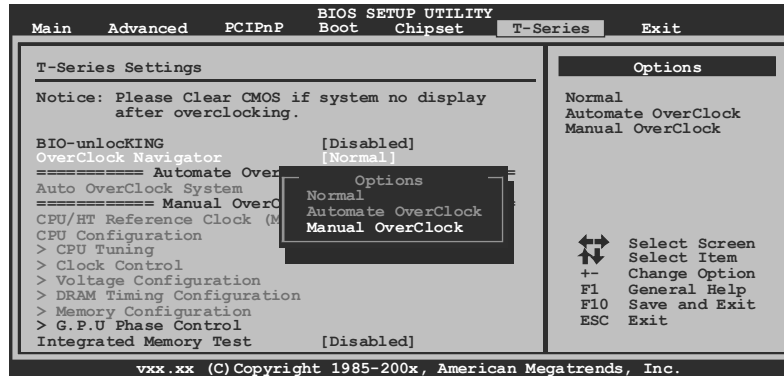

### BIO-unlockKING

This item allows you to activate BIO-unlockKING function.

### CPU/HT Reference Clock (MHz)

CPU Frequency is directly in proportion to system performance. To maintain the system stability, CPU voltage needs to be increased also when raising CPU frequency.

### CPU Configuration

This item provides several fixed modes of CPU configuration.

### CPU Tuning

Enter this function for more advanced CPU settings.

### Clock Control

Enter this function for more clock settings.

**Voltage Configuration**

Enter this function for more advanced voltage settings.

**DRAM Timing Configuration**

Enter this function for more advanced DRAM clock settings.

**Memory Configuration**

Enter this function for more advanced memory settings.

**NOTE**

Overclock is an optional process, but not a “must-do” process; it is not recommended for inexperienced users. Therefore, we will not be responsible for any hardware damage which may be caused by overclocking. We also would not guarantee any overclocking performance.

**Automatic Overclock System (A.O.S.)**

For beginners in overclock field, BET had developed an easy, fast, and powerful feature to increase the system performance, named A.O.S. Based on many tests and experiments, A.O.S. provides 3 ideal overclock configurations that are able to raise the system performance in a single step.

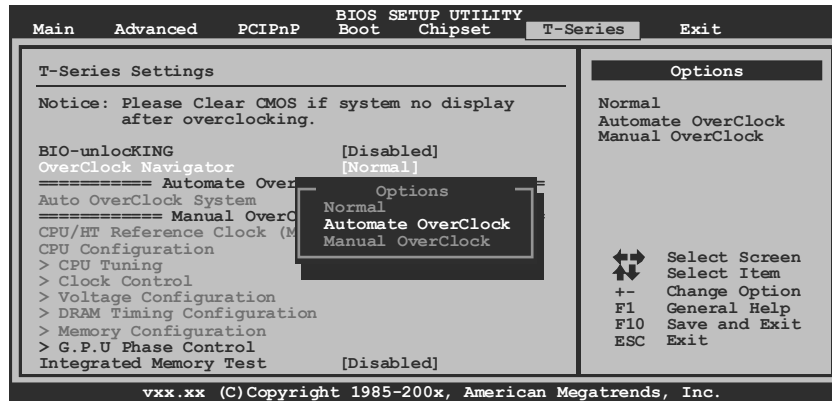

### V6 Tech Engine

This engine will make a good over-clock performance.

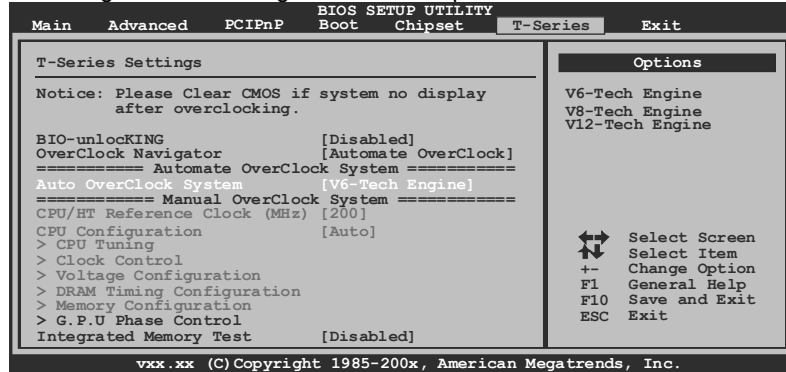

### V8 Tech Engine

This engine will make a better over-clock performance.

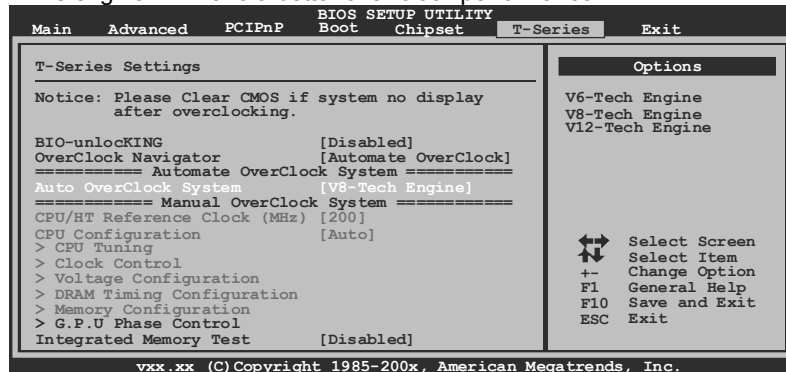

### V12 Tech Engine

This engine will make a best over-clock performance.

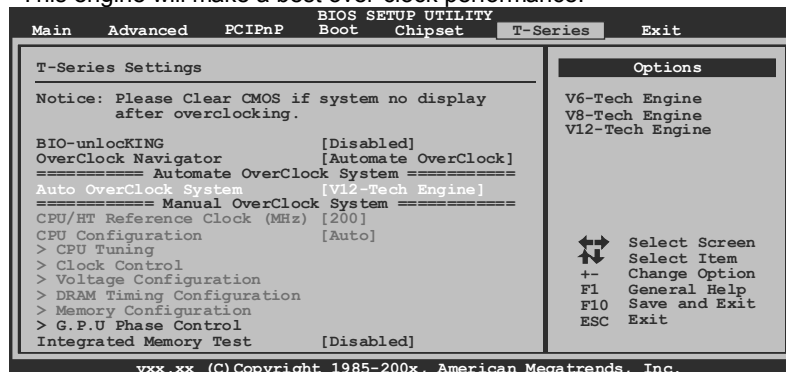

**Notices:**  
 Not all types of AMD CPU perform above overclock setting ideally; the difference will be based on the selected CPU model.

**B. Memory Integration Test (M.I.T.)**

This function is under “Overclocking Navigator Engine” item.  
 MIT allows users to test memory compatibilities, and no extra devices or software are needed.

**Step 1**

The default setting under this item is “Disabled”; the condition parameter should be changed to “Enable” to proceed this test.

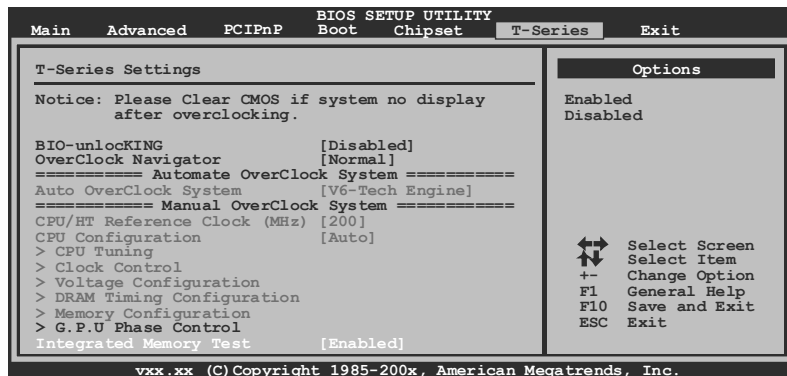
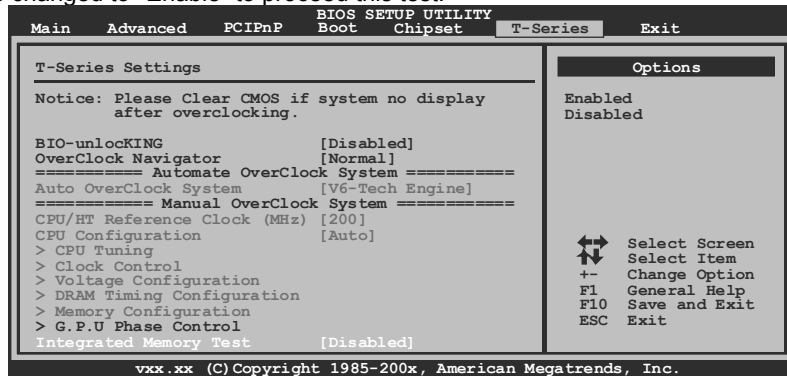

**Step 2**

Save and Exit from CMOS setup and reboot the system to activate this test.  
 Run this test for 5 minutes (minimum) to ensure the memory stability.

**Step 3**

When the process is done, change the setting back from “Enable” to “Disable” to complete the test.

### C. BIO-Flasher

BIO-Flasher is a BIOS flashing utility providing you an easy and simple way to update your BIOS via USB pen drive or floppy disk.

The BIO-Flasher is built in the BIOS chip. To enter the utility, **press <F12> during the Power-On Self Tests (POST)** procedure while booting up.

#### Updating BIOS with BIO-Flasher

1. Go to the website to download the latest BIOS file for the motherboard.
2. Then, save the BIOS file into a USB pen drive or a floppy disk.
3. Insert the USB pen drive or the floppy disk that contains the BIOS file to the USB port or the floppy disk drive.
4. Power on or reset the computer and then press **<F12>** during the **POST** process. A select dialog as the picture on the right appears. Select the device contains the BIOS file and press **<Enter>** to enter the utility.

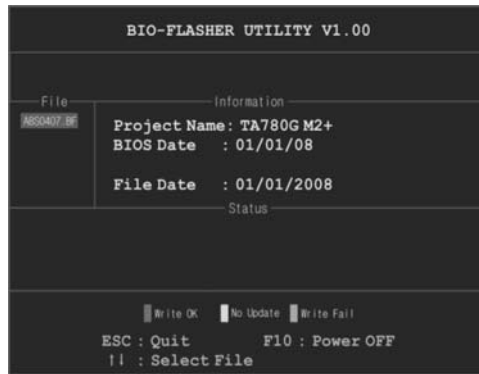

5. The utility will show the BIOS files and their respective information. Select the proper BIOS file and press **<Enter>** then **<Y>** to perform the BIOS update process.

6. After the update process, the utility will ask you to reboot the system. Press **<Y>** to proceed. BIOS update completes.



- This utility only allows storage device with FAT32/16 format and single partition.
- Shutting down or resetting the system while updating the BIOS will lead to system boot failure.

**D. Self Recovery System (S.R.S.)**

This function can't be seen under BIOS setup; and is always on whenever the system starts up.

However, it can prevent system hang-up due to inappropriate overclock actions.

When the system hangs up, S.R.S. will automatically log in the default BIOS setting, and all overclock settings will be re-configured.

**E. Smart Fan Function**

Smart Fan Function is under "Smart Fan Configuration" in "Advanced Menu".

This is a brilliant feature to control CPU/System Temperature vs. Fan speed.

When enabling Smart Fan function, Fan speed is controlled automatically by CPU/System temperature.

This function will protect CPU/System from overheat problem and maintain the system temperature at a safe level.

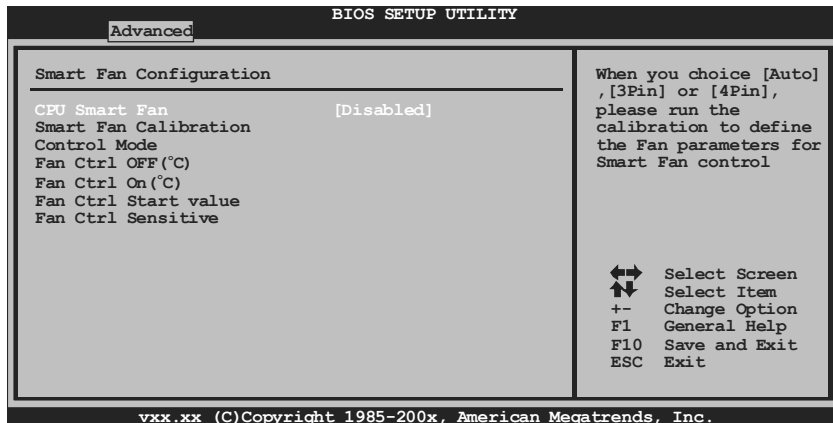
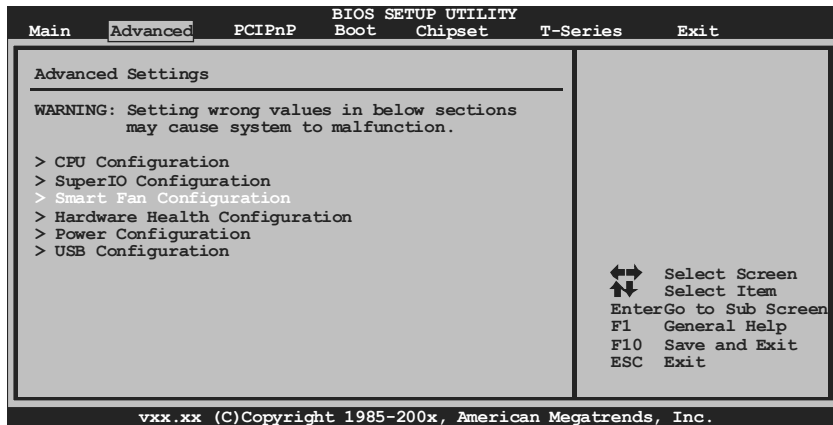

### Smart Fan Calibration

Choose this item and then the BIOS will automatically test and detect the CPU/System fan functions and show CPU/System fan speed.

### Control Mode

This item provides several operation modes of the fan.

### Fan Ctrl OFF(°C)

If the CPU/System temperature is lower than the set value, the CPU/System fan will turn off. The range is from 0~127, with an interval of 1.

### Fan Ctrl On(°C)

The CPU/System fan starts to work when CPU/System temperature arrives to this set value. The range is from 0~127, with an interval of 1.

### Fan Ctrl Start Value

When CPU/System temperature arrives to the set value, the CPU/System fan will work under Smart Fan Function mode. The range is from 0~127, with an interval of 1.

### Fan Ctrl Sensitive

Increasing the value of slope PWM will raise the speed of CPU/System fan. The range is from 1~127, with an interval of 1.

## F. CMOS Reloading Program

It allows users to save different CMOS settings into BIOS-ROM.

Users are able to reload any saved CMOS setting for customizing system configurations. Moreover, users are able to save an ideal overclock setting during overclock operation.

There are 10 sets of record addresses in total, and users are able to name the CMOS data according to personal preference.

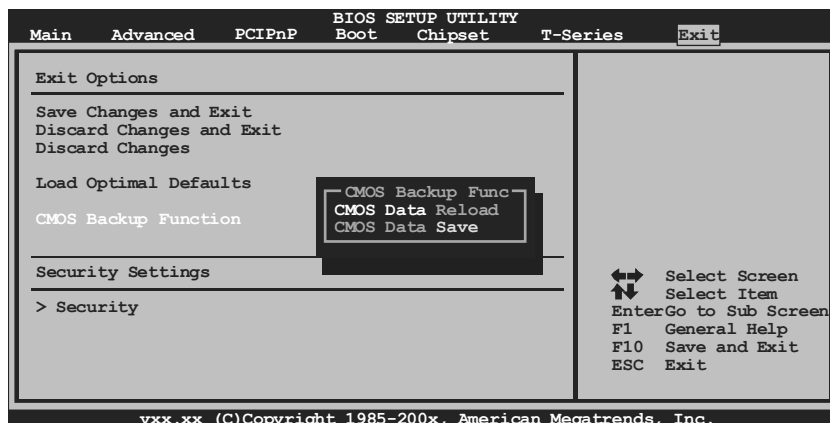



## 6.2 T-SERIES SOFTWARE

### Installing T-Series Software

1. Insert the Setup CD to the optical drive. The drivers installation program would appear if the Auto-run function has been enabled.
2. Select **Software Installation**, and then click on the respective software title.
3. Follow the on-screen instructions to complete the installation.

### Launching T-Series Software

After the installation process is completed, you will see the software icon showing on the desktop. Double-click the icon to launch it.

### TOverclocker

TOverclocker presents a simple Windows-based system performance enhancement and manageability utility. It features several powerful and easy to use tools such as Overclocking for enhancing system performance, also for special enhancement on CPU and Memory. Smart-Fan management and PC health are for monitoring system status. This utility also allows you to make overclocking profiles saving unlimitedly, and pre-set OC modes are for easy OC. (The illustration below is for reference only)

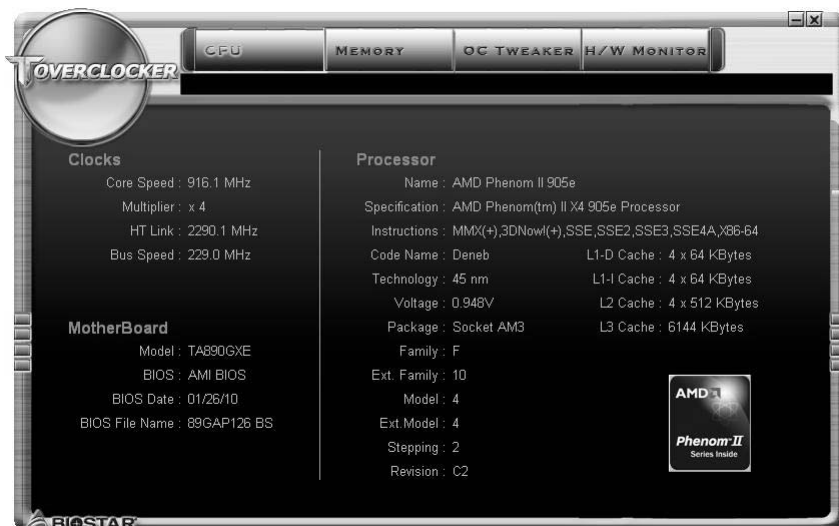

## Motherboard Manual

---



The **CPU** tab provides information on the CPU and motherboard.



The **Memory** tab provides information on the memory module(s).

You can select memory module on a specific slot to see its information.



The **OC Tweaker** tab allows you to change system clock settings and voltages settings. It also provides six pre-set modes for you:



**Six Pre-set Modes:** V3, V6, V9, V12, V15, AUTO for different overclocking experience.

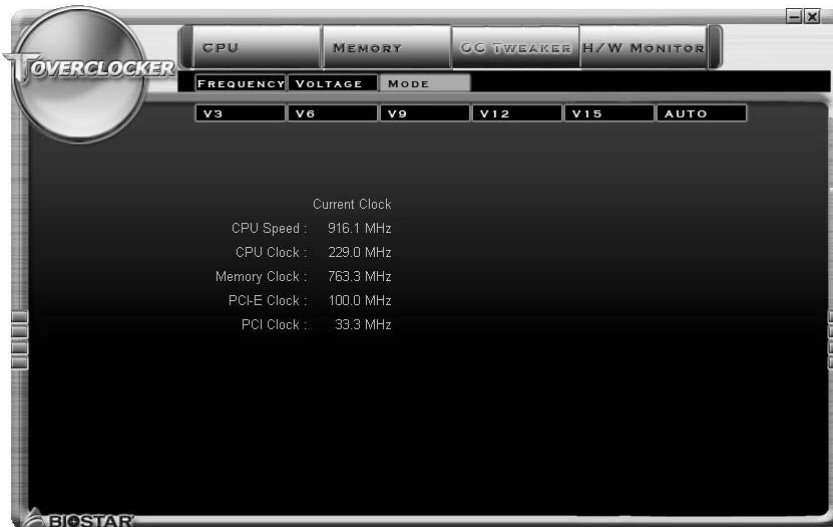

The **HW Monitor** tab allows you to monitor hardware voltage, fan speed, and temperature. Besides, you also can set related values for CPU Smart Fan.





Pressing **TOVERCLOCKER** logo will display information about manufacturer and software version. You can update current version by clicking the button "Live Update."

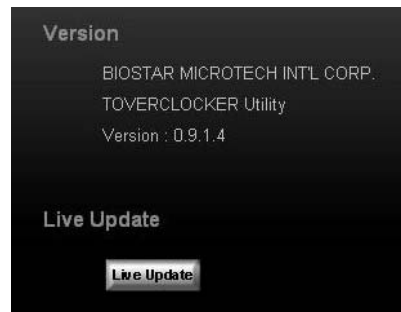

### Green Power II Utility

BIOSTAR G.P.U II (Green Power Utility) is a new function. The utility enhances energy efficiency by disabling extra phases while CPU is on light loading; it features 4+1 power phases, current power saving, and total power saving. This tool integrates a friendly GUI to monitor your CPU Usage, CPU Watt, and CPU Temperature. Moreover, it optimizes power saving and best power efficiency on your system. (The illustration below is for reference only)

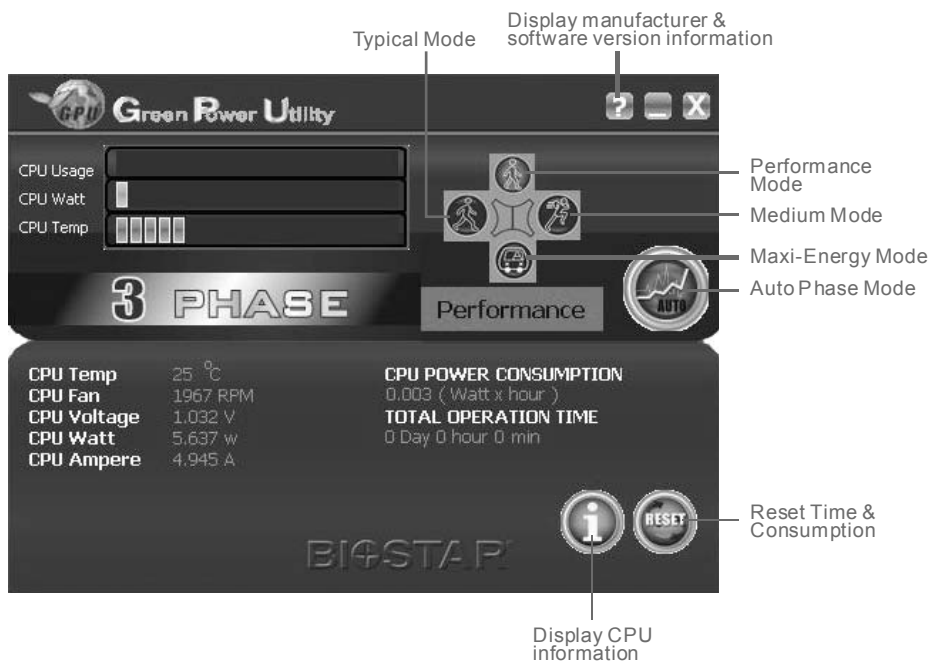

### **G.P.U Mode Setting**

This utility provides five modes, upon your requirements, to improve system performance or to save power consumption.

**Note:** Even if the modes saving more power consumption are chosen, the system still can keep excellent performance.

- **Auto Phase Mode**

System switches the mode automatically according to current system loading condition.

- **Performance Mode**

This is the mode saving power consumption most. Least energy will be used in the system.

- **Typical Mode**

Compared with that in Performance Mode, energy consumption in this mode is a little bit more.

- **Medium Mode**

This is the standard system power saving mode.

- **Maxi-Energy Mode**

This is the best system performance mode.

### eHot-Line (Optional)

eHot-Line is a convenient utility that helps you to contact with our Tech-Support system. This utility will collect the system information which is useful for analyzing the problem you may have encountered, and then send these information to our tech-support department to help you fix the problem.

 Before you use this utility, please set Outlook Express as your default e-mail client application program.

\* represents important information that you must provide. Without this information, you may not be able to send out the mail.

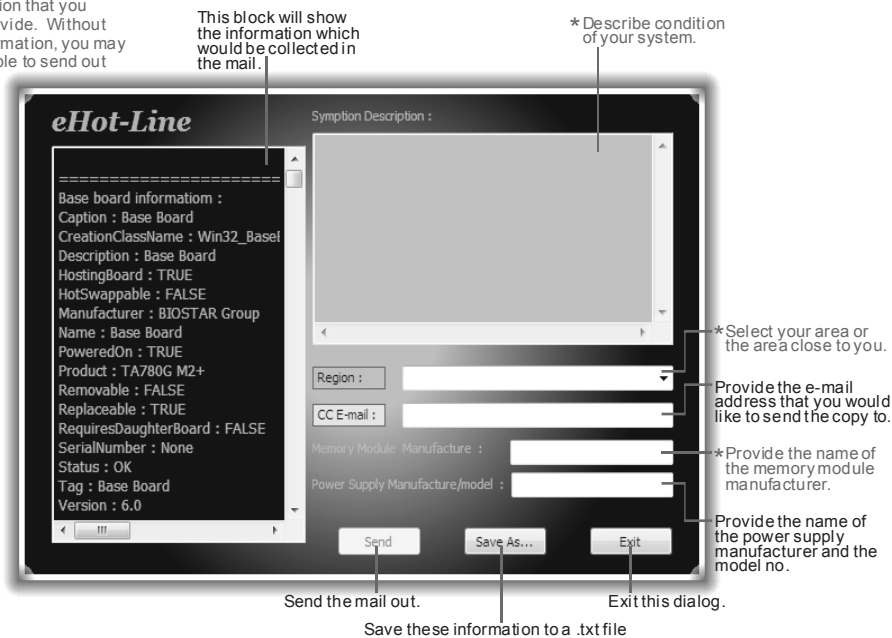

The screenshot shows the eHot-Line utility window. On the left, a text box displays system information: Base board information: Caption: Base Board, CreationClassName: Win32\_Base, Description: Base Board, HostingBoard: TRUE, HotSwappable: FALSE, Manufacturer: BIOSTAR Group, Name: Base Board, PoweredOn: TRUE, Product: TA780G M2+, Removable: FALSE, Replaceable: TRUE, RequiresDaughterBoard: FALSE, SerialNumber: None, Status: OK, Tag: Base Board, Version: 6.0. On the right, there is a 'Symptom Description' text area, a 'Region' dropdown menu, a 'CC E-mail' text field, and fields for 'Memory Module: Manufacture' and 'Power Supply Manufacture/model'. At the bottom are 'Send', 'Save As...', and 'Exit' buttons. Annotations with arrows point to these elements: 'This block will show the information which would be collected in the mail.' points to the system information text box; '\* Describe condition of your system.' points to the Symptom Description text area; '\* Select your area or the area close to you.' points to the Region dropdown; 'Provide the e-mail address that you would like to send the copy to.' points to the CC E-mail field; '\* Provide the name of the memory module manufacturer.' points to the Memory Module field; 'Provide the name of the power supply manufacturer and the model no.' points to the Power Supply field; 'Send the mail out.' points to the Send button; 'Exit this dialog.' points to the Exit button; and 'Save these information to a .txt file' points to the Save As... button.

After filling up this information, click **“Send”** to send the mail out. A warning dialog would appear asking for your confirmation; click **“Send”** to confirm or **“Do Not Send”** to cancel.



If you want to save this information to a .txt file, click **“Save As...”** and then you will see a saving dialog appears asking you to enter file name.

Enter the file name and then click “Save”. Your system information will be saved to a .txt file.

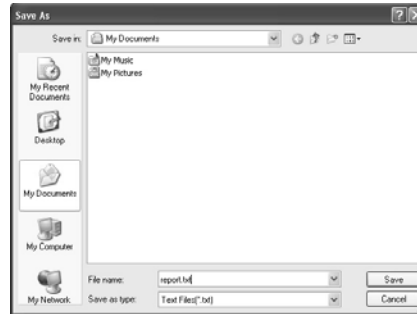

Open the saved .txt file, you will see your system information including motherboard/BIOS/CPU/video/device/OS information. This information is also included in the sent mail.



**We will not share customer’s data with any other third parties,** so please feel free to provide your system information while using eHot-Line service.



If you are not using Outlook Express as your default e-mail client application, you may need to save the system information to a .txt file and send the file to our tech support with other e-mail application. Go to the following web <http://www.biostar.com.tw/app/en-us/about/contact.php> for getting our contact information.

## BIOS Update

BIOS Update is a convenient utility which allows you to update your motherboard BIOS under Windows system.

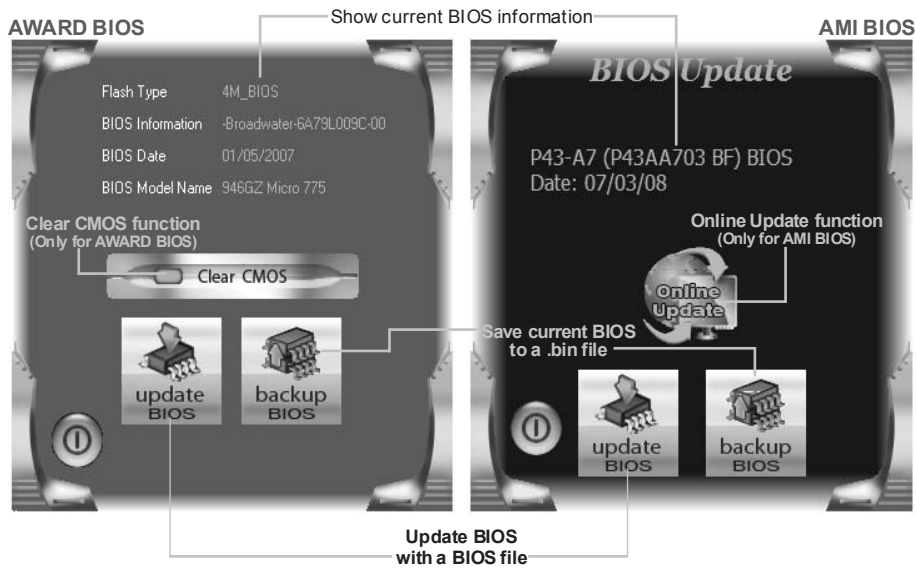

### <Backup BIOS>

Once click on this button, the saving dialog will show. Choose the position to save file and enter file name. (We recommend that the file name should be English/number and no longer than 7 characters.) Then click **Save**.

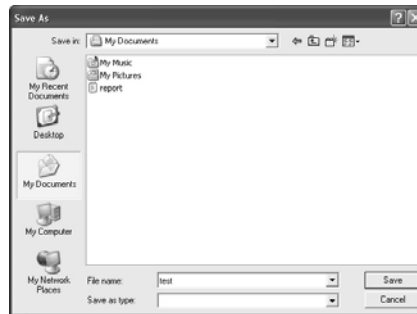



**<Update BIOS>**

Before doing this, please download the proper BIOS file from the website.

For AWARD BIOS, update BIOS procedure should be run with Clear CMOS function, so please check on Clear CMOS first.

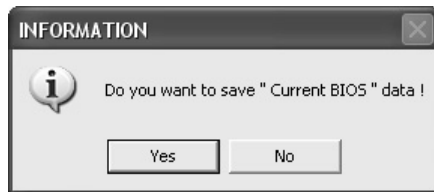
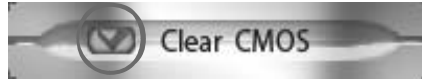

Then click Update BIOS button, a dialog will show for asking you backup current BIOS. Click **Yes** for BIOS backup and refer to the Backup BIOS procedure; or click **No** to skip this procedure.

After the BIOS Backup procedure, the open dialog will show for requesting the BIOS file which is going to be updated. Please choose the proper BIOS file for updating, then click on **Open**.

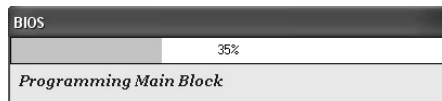
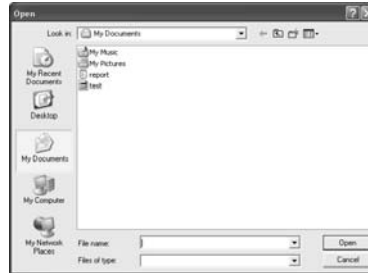

The utility will update BIOS with the proper BIOS file, and this process may take minutes. Please do not open any other applications during this process.

After the BIOS Update process, click on **OK** to restart the system.

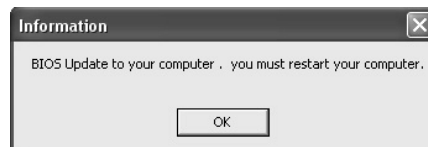

While the system boots up and the full screen logo shows, press  <Delete> key to enter BIOS setup.

In the BIOS setup, use the **Load Optimized Defaults** function and then **Save and Exit Setup** to exit BIOS setup. BIOS Update is completed.

**<Online Update> (for AMI BIOS only)**

Automatically download and update the latest BIOS via internet; **make sure that the computer is connected to the internet before using this function.**

After clicking on the **Online Update** button, the utility will search for the latest BIOS from internet. If there is a new BIOS version, the utility will ask you to download it. Click **Yes** to proceed.

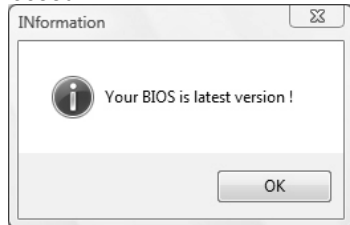
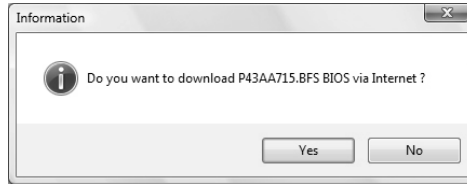

If there is no other newer BIOS version, the utility will also tell you that your BIOS has been the latest version.

Download completes; the utility will ask you to program (update) the BIOS. Click **Yes** to proceed.

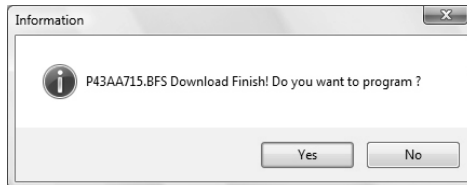

The programming procedure may take minutes, **please do not make any operation during the programming process.**

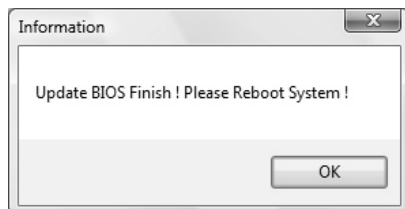

After the updating process, the utility will ask you to reboot the system. Click **OK** to reboot.

While the system boots up and the full screen logo shows, press  <Delete> key to enter BIOS setup.

In the BIOS setup, use the **Load Optimized Defaults** function and then **Save and Exit Setup** to exit BIOS setup. Online Update is completed.



All the information and content above about the T-Series software are subject to be changed without notice. For better performance, the software is being continuously updated. The information and pictures described above are for your reference only. The actual information and settings on board may be slightly different from this manual.

## CHAPTER 7: USEFUL HELP

### 7.1 DRIVER INSTALLATION NOTE

After you installed your operating system, please insert the Fully Setup Driver CD into your optical drive and install the driver for better system performance.

You will see the following window after you insert the CD

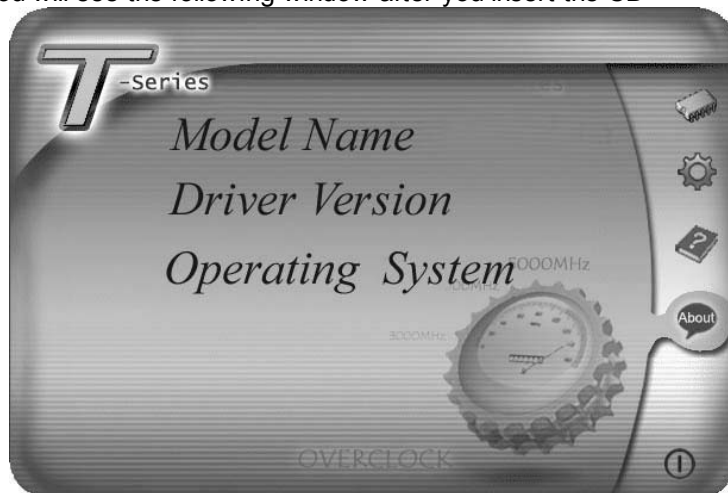

The setup guide will auto detect your motherboard and operating system.

**Note:**

If this window didn't show up after you insert the Driver CD, please use file browser to locate and execute the file **SETUP.EXE** under your optical drive.

#### A. Driver Installation

To install the driver, please click on the Driver icon. The setup guide will list the compatible driver for your motherboard and operating system. Click on each device driver to launch the installation program.

#### B. Software Installation

To install the software, please click on the Software icon. The setup guide will list the software available for your system, click on each software title to launch the installation program.

#### C. Manual

Aside from the paperback manual, we also provide manual in the Driver CD. Click on the Manual icon to browse for available manual.

**Note:**

You will need Acrobat Reader to open the manual file. Please download the latest version of Acrobat Reader software from <http://www.adobe.com/products/acrobat/readstep2.html>

## 7.2 EXTRA INFORMATION

### ***CPU Overheated***

If the system shutdown automatically after power on system for seconds, that means the CPU protection function has been activated.

When the CPU is over heated, the motherboard will shutdown automatically to avoid a damage of the CPU, and the system may not power on again.

In this case, please double check:

1. The CPU cooler surface is placed evenly with the CPU surface.
2. CPU fan is rotated normally.
3. CPU fan speed is fulfilling with the CPU speed.

After confirmed, please follow steps below to relief the CPU protection function.

1. Remove the power cord from power supply for seconds.
2. Wait for seconds.
3. Plug in the power cord and boot up the system.

Or you can:

1. Clear the CMOS data.  
(See "Close CMOS Header: JCMOS1" section)
2. Wait for seconds.
3. Power on the system again.

## 7.3 AMI BIOS BEEP CODE

### Boot Block Beep Codes

Number of Beeps	Description
1	No media present. (Insert diskette in floppy drive A:)
2	"AMIBOOT.ROM" file not found in root directory of diskette in A:
3	Insert next diskette if multiple diskettes are used for recovery
4	Flash Programming successful
5	File read error
7	No Flash EPROM detected
10	Flash Erase error
11	Flash Program error
12	"AMIBOOT.ROM" file size error
13	BIOS ROM image mismatch (file layout does not match image present in flash device)

### POST BIOS Beep Codes

Number of Beeps	Description
1	Memory refresh timer error
3	Base memory read/write test error
6	Keyboard controller BAT command failed
7	General exception error (processor exception interrupt error)
8	Display memory error (system video adapter)

### Troubleshooting POST BIOS Beep Codes

Number of Beeps	Troubleshooting Action
1, 3	Reseat the memory, or replace with known good modules.
6, 7	<p>Fatal error indicating a serious problem with the system. Consult your system manufacturer. Before declaring the motherboard beyond all hope, eliminate the possibility of interference by a malfunctioning add-in card. Remove all expansion cards except the video adapter.</p> <ul style="list-style-type: none"> <li>● If beep codes are generated when all other expansion cards are absent, consult your system manufacturer's technical support.</li> <li>● If beep codes are not generated when all other expansion cards are absent, one of the add-in cards is causing the malfunction. Insert the cards back into the system one at a time until the problem happens again. This will reveal the malfunctioning card.</li> </ul>
8	If the system video adapter is an add-in card, replace or reseat the video adapter. If the video adapter is an integrated part of the system board, the board may be faulty.

## 7.4 TROUBLESHOOTING

Probable	Solution
<ol style="list-style-type: none"> <li>1. There is no power in the system. Power LED does not shine; the fan of the power supply does not work</li> <li>2. Indicator light on keyboard does not shine.</li> </ol>	<ol style="list-style-type: none"> <li>1. Make sure power cable is securely plugged in.</li> <li>2. Replace cable.</li> <li>3. Contact technical support.</li> </ol>
<p>System is inoperative. Keyboard lights are on, power indicator lights are lit, and hard drives are running.</p>	<p>Using even pressure on both ends of the DIMM, press down firmly until the module snaps into place.</p>
<p>System does not boot from a hard disk drive, but can be booted from optical drive.</p>	<ol style="list-style-type: none"> <li>1. Check cable running from disk to disk controller board. Make sure both ends are securely plugged in; check the drive type in the standard CMOS setup.</li> <li>2. Backing up the hard drive is extremely important. All hard disks are capable of breaking down at any time.</li> </ol>
<p>System only boots from an optical drive. Hard disks can be read, applications can be used, but system fails to boot from a hard disk.</p>	<ol style="list-style-type: none"> <li>1. Back up data and applications files.</li> <li>2. Reformat the hard drive. Re-install applications and data using backup disks.</li> </ol>
<p>Screen message shows "Invalid Configuration" or "CMOS Failure."</p>	<p>Review system's equipment. Make sure correct information is in setup.</p>
<p>System cannot boot after user installs a second hard drive.</p>	<ol style="list-style-type: none"> <li>1. Set master/slave jumpers correctly.</li> <li>2. Run SETUP program and select correct drive types. Call the drive manufacturers for compatibility with other drives.</li> </ol>

This page is intentionally left blank.

## APPENDIX: SPEC IN OTHER LANGUAGES

### GERMAN

<i>Spezifikationen</i>		
CPU	Socket AM3 AMD Sempron / Phenom II / Athlon II Prozessoren	Die AMD 64-Architektur unterstützt eine 32-Bit- und 64-Bit-Datenverarbeitung Unterstützt Hyper Transport 3.0
FSB	Unterstützt HyperTransport 3.0 mit einer Bandbreite von bis zu 5.2 GT/s	
Chipsatz	AMD 880G AMD SB710	
Super E/A	ITE 8721 Bietet die häufig verwendeten alten Super E/A-Funktionen. Low Pin Count-Schnittstelle	Umgebungskontrolle, Hardware-Überwachung Lüfterdrehzahl-Controller "Smart Guardian"-Funktion von ITE
Arbeitsspeicher	DDR3 DIMM-Steckplätze x 4 Max. 16GB Arbeitsspeicher Jeder DIMM unterstützt 512MB/ 1GB/2GB/4GB DDR3.	Dual-Kanal DDR3 Speichermodul Unterstützt DDR3 800 / 1066 / 1333 Unterstützt DDR3 1600 (OC)
Grafik	AMD 880G (Radeon HD4250)	Max. 512MB gemeinsam benutzter Videospeicher Onboard Side-Port-Speicher 128MB DDR3 Unterstützt DVI/HDMI/UVD/HDCP
SATA 2	Integrierter Serial ATA-Controller	Datentransferrate bis zu 3 Gb/s Konform mit der SATA-Spezifikation Version 2.0 Unterstützt RAID 0,1,10
LAN	Realtek RTL8111E	10 / 100 / 1000 Mb/s Auto-Negotiation Halb-/ Vollduplex-Funktion
Audio-Codec	ALC892	5.1-Kanal-Audioausgabe Unterstützt High-Definition Audio
Steckplätze	PCI Steckplatz x2 PCI Express Gen2 x16 Steckplatz x1	



## TA880GB+/TA880GB

<b>Spezifikationen</b>			
Onboard-Anschluss	SATA-Anschluss	x6	Jeder Anschluss unterstützt 1 SATA-Laufwerk
	Fronttafelanschluss	x1	Unterstützt die FronttafelFunktionen
	Front-Audioanschluss	x1	Unterstützt die Fronttafel-Audioanschlussfunktion
	S/PDIF Ausgangsanschluss	x1	Unterstützt die digitale Audioausgabefunktion
	CPU-Lüfter-Sockel	x1	CPU-Lüfterstromversorgungsanschluss (mit Smart Fan-Funktion)
	System-Lüfter-Sockel	x2	System-Lüfter-Stromversorgungsanschluss
	"CMOS löschen"-Sockel	x1	
	USB-Anschluss	x3	Jeder Anschluss unterstützt 2 Fronttafel-USB-Anschlüsse
	Druckeranschluss Anschluss	x1	Jeder Anschluss unterstützt 1 Druckeranschluss
	Serieller Anschluss	x1	
	Verbraucher-IR Anschluss	x1	
	Stromanschluss (24-polig)	x1	
Stromanschluss (4-polig)	x1		
Rückseiten-E/A	PS/2-Tastatur / Maus	x1	
	HDMI-Anschluss	x1	
	VGA-Anschluss	x1	
	DVI-D-Anschluss	x1	
	LAN-Anschluss	x1	
	USB-Anschluss	x4	
	Audioanschluss	x3	
Platinengröße	233 mm (B) X 244 mm (L)		uATX
OS-Unterstützung	Windows XP / Vista / 7		Biostar behält sich das Recht vor, ohne Ankündigung die Unterstützung für ein Betriebssystem hinzuzufügen oder zu entfernen.

**FRENCH**

SPEC		
UC	Socket AM3 Processeurs AMD Sempron / Phenom II / Athlon II	L'architecture AMD 64 permet le calcul 32 et 64 bits Prend en charge Hyper Transport 3.0
Bus frontal	Prend en charge Hyper Transport 3.0 jusqu'à une bande passante de 5.2 GT/s	
Chipset	AMD 880G AMD SB710	
Super E/S	ITE 8721 Fournit la fonctionnalité de Super E/S patrimoniales la plus utilisée. Interface à faible compte de broches	Initiatives de contrôle environnementales, Moniteur de matériel Contrôleur de vitesse de ventilateur Fonction "Gardien intelligent" de l'ITE
Mémoire principale	Fentes DDR3 DIMM x 4 Capacité mémoire maximale de 16 Go Chaque DIMM prend en charge des DDR3 de 512Mo/1Go/2Go/4Go	Module de mémoire DDR3 à mode à double voie Prend en charge la DDR3 800 / 1066 / 1333 Prend en charge la DDR3 1600 (OC)
Graphiques	AMD 880G (Radeon HD4250)	Mémoire vidéo partagée maximale de 512 Mo Bord bâbord mémoire 128 Mo DDR3 Prise en charge DVI/HDMI/UVD/HDCP
SATA 2	Contrôleur Serial ATA intégré	Taux de transfert jusqu'à 3 Go/s. Conforme à la spécification SATA Version 2.0 Prise en charge RAID 0,1,10
LAN	Realtek RTL8111E	10 / 100 / 1000 Mb/s négociation automatique Half / Full duplex capability
Codec audio	ALC892	Sortie audio à 5.1 voies Prise en charge de l'audio haute définition
Fentes	Fente PCI x2 Fente PCI Express Gen2 x16 x1	

**TA880GB+/TA880GB**

<i>SPEC</i>			
Connecteur embarqué	Connecteur SATA	x6	Chaque connecteur prend en charge 1 périphérique SATA
	Connecteur du panneau avant	x1	Prend en charge les équipements du panneau avant
	Connecteur Audio du panneau avant	x1	Prend en charge la fonction audio du panneau avant
	Connecteur de sortie S/PDIF	x1	Prend en charge la fonction de sortie audio numérique
	Embase de ventilateur UC	x1	Alimentation électrique du ventilateur UC (avec fonction de ventilateur intelligent)
	Embase de ventilateur système	x2	Alimentation électrique du ventilateur système
	Embase d'effacement CMOS	x1	
	Connecteur USB	x3	Chaque connecteur prend en charge 2 ports USB de panneau avant
	Connecteur de Port d'imprimante	x1	Chaque connecteur prend en charge 1 Port d'imprimante
	Port série	x1	
	Connecteur de IR du consommateur	x1	
	Connecteur d'alimentation (24 broches)	x1	
	Connecteur d'alimentation (4 broches)	x1	
E/S du panneau arrière	Clavier / Souris PS/2	x1	
	Port HDMI	x1	
	Port VGA	x1	
	Port DVI-D	x1	
	Port LAN	x1	
	Port USB	x4	
	Fiche audio	x3	
Dimensions de la carte	233 mm (l) X 244 mm (H)		uATX
Support SE	Windows XP / Vista / 7		Biostar se réserve le droit d'ajouter ou de supprimer le support de SE avec ou sans préavis.

**ITALIAN**

<b>SPECIFICA</b>		
CPU	Socket AM3 Processori AMD Sempron / Phenom II / Athlon II	L'architettura AMD 64 abilita la computazione 32 e 64 bit Supporto di Hyper Transport 3.0
FSB	Supporto di HyperTransport 3.0 fino a 5.2 GT/s di larghezza di banda	
Chipset	AMD 880G AMD SB710	
Super I/O	ITE 8721 Fornisce le funzionalità legacy Super I/O usate più comunemente. Interfaccia LPC (Low Pin Count)	Funzioni di controllo dell'ambiente: Monitoraggio hardware Controller velocità ventolina Funzione "Smart Guardian" di ITE
Memoria principale	Alloggi DIMM DDR3 x 4 Capacità massima della memoria 16GB Ciascun DIMM supporta DDR3 512MB/1GB/2GB/4GB	Modulo di memoria DDR3 a canale doppio Supporto di DDR3 800 / 1066 / 1333 Supporto di DDR3 1600 (OC)
Grafica	AMD 880G (Radeon HD4250)	La memoria video condivisa massima è di 512 MB Porto di memoria a bordo laterale 128MB DDR3 Supporto DVI/HDMI/UVD/HDCP
SATA 2	Controller Serial ATA integrato	Velocità di trasferimento dei dati fino a 3 Gb/s. Compatibile specifiche SATA Versione 2.0 Supporto RAID 0,1,10
LAN	Realtek RTL8111E	Negoziazione automatica 10 / 100 / 1000 Mb/s Capacità Half / Full Duplex
Codec audio	ALC892	Uscita audio 5.1 canali Supporto audio High-Definition (HD)
Alloggi	Alloggio PCI x2 Alloggio PCI Express Gen2 x16 x1	

<b>SPECIFICA</b>			
Connettori su scheda	Connettore SATA	x6	Ciascun connettore supporta 1 unità SATA
	Connettore pannello frontale	x1	Supporta i servizi del pannello frontale
	Connettore audio frontale	x1	Supporta la funzione audio pannello frontale
	Connettore output S/PDIF	x1	Supporta la funzione d'output audio digitale
	Collettore ventolina CPU	x1	Alimentazione ventolina CPU (con funzione Smart Fan)
	Collettore ventolina sistema	x2	Alimentazione ventolina di sistema
	Collettore cancellazione CMOS	x1	
	Connettore USB	x3	Ciascun connettore supporta 2 porte USB pannello frontale
	Connettore Porta stampante	x1	Ciascun connettore supporta 1 Porta stampante
	Porta seriale	x1	
	Connettore IR del consumatore	x1	
	Connettore alimentazione (24 pin)	x1	
	Connettore alimentazione (4 pin)	x1	
I/O pannello posteriore	Tastiera / Mouse PS/2	x1	
	Porta HDMI	x1	
	Porta VGA	x1	
	Porta DVI-D	x1	
	Porta LAN	x1	
	Porta USB	x4	
	Connettore audio	x3	
Dimensioni scheda	233 mm (larghezza) x 244 mm (altezza)		uATX
Sistemi operativi supportati	Windows XP / Vista / 7		Biostar si riserva il diritto di aggiungere o rimuovere il supporto di qualsiasi sistema operativo senza preavviso.

**SPANISH**

<i>Especificación</i>		
CPU	Conector AM3 Procesadores AMD Sempron / Phenom II / Athlon II	La arquitectura AMD 64 permite el procesado de 32 y 64 bits Soporta las tecnologías Hyper Transport 3.0
FSB	Admite HyperTransport 3.0 con un ancho de banda de hasta 5.2 GT/s	
Conjunto de chips	AMD 880G AMD SB710	
Súper E/S	ITE 8721 Le ofrece las funcionalidades heredadas de uso más común Súper E/S. Interfaz de cuenta Low Pin	Iniciativas de control de entorno, Monitor hardware Controlador de velocidad de ventilador Función "Guardia inteligente" de ITE
Memoria principal	Ranuras DIMM DDR3 x 4 Capacidad máxima de memoria de 16GB Cada DIMM admite DDR de 512MB/1GB/2GB/4GB	Módulo de memoria DDR3 de canal Doble Admite DDR3 de 800 / 1066 / 1333 Admite DDR3 de 1600 (OC)
Gráficos	AMD 880G (Radeon HD4250)	Memoria máxima de vídeo compartida de 512 MB Puerto a bordo lado de la memoria 128MB DDR3 Admite DVI/HDMI/UVD/HDCP
SATA 2	Controlador ATA Serie Integrado	Tasas de transferencia de hasta 3 Gb/s. Compatible con la versión SATA 2.0 Admite RAID 0,1,10
Red Local	Realtek RTL8111E	Negociación de 10 / 100 / 1000 Mb/s Funciones Half / Full dúplex
Códecs de sonido	ALC892	Salida de sonido de 5.1 canales Soporte de sonido de Alta Definición
Ranuras	Ranura PCI X2 Ranura PCI express Gen2 x16 X1	

<b>Especificación</b>			
Conectores en placa	Conector SATA	X6	Cada conector soporta 1 dispositivos SATA
	Conector de panel frontal	X1	Soporta instalaciones en el panel frontal
	Conector de sonido frontal	X1	Soporta funciones de sonido en el panel frontal
	Conector de salida S/PDIF	X1	Soporta función de salida de sonido digital
	Cabecera de ventilador de CPU	X1	Fuente de alimentación de ventilador de CPU (con función Smart Fan)
	Cabecera de ventilador de sistema	X2	Fuente de alimentación de ventilador de sistema
	Cabecera de borrado de CMOS	X1	
	Conector USB	X3	Cada conector soporta 2 puertos USB frontales
	Conector Puerto de impresora	X1	Cada conector soporta 1 Puerto de impresora
	Puerto serie	X1	
	Conector de IR del consumidor	X1	
	Conector de alimentación (24 patillas)	X1	
Panel trasero de E/S	Conector de alimentación (4 patillas)	X1	
	Teclado / Ratón PS/2	X1	
	Ratón HDMI	X1	
	Puerto VGA	X1	
	Puerto DVI-D	X1	
	Puerto de red local	X1	
	Puerto USB	X4	
Conector de sonido	X3		
Tamaño de la placa	233 mm. (A) X 244 mm. (H)	µATX	
Soporte de sistema operativo	Windows XP / Vista / 7		Biostar se reserva el derecho de añadir o retirar el soporte de cualquier SO con o sin aviso previo.

**PORTUGUESE**

<b>ESPECIFICAÇÕES</b>		
CPU	Socket AM3 Processadores AMD Sempron / Phenom II / Athlon II	A arquitetura AMD 64 permite uma computação de 32 e 64 bits Suporta as tecnologias Hyper Transport 3.0
FSB	Suporta a tecnologia HyperTransport 3.0 com uma largura de banda até 5.2 GT/s	
Chipset	AMD 880G AMD SB710	
Especificação do Super I/O	ITE 8721 Proporciona as funcionalidades mais utilizadas em termos da especificação Super I/O. Interface LPC (Low Pin Count).	Iniciativas para controlo do ambiente Monitorização do hardware Controlador da velocidade da ventoinha Função "Smart Guardian" da ITE
Memória principal	Ranuras DIMM DDR3 x 4 Capacidade máxima de memória: 16 GB Cada módulo DIMM suporta uma memória DDR3 de 512MB/ 1GB/2GB/4GB	Módulo de memória DDR3 de canal duplo Suporta módulos DDR3 800 / 1066 / 1333 Suporta módulos DDR3 1600 (OC)
Placa gráfica	AMD 880G (Radeon HD4250)	Memória de vídeo máxima partilhada: 512 MB Onboard porta lateral 128MB de memória DDR3 Suporta as funções DVI/HDMI/UVD/HDCP
SATA 2	Controlador Serial ATA integrado	Velocidades de transmissão de dados até 3 Gb/s. Compatibilidade com a especificação SATA versão 2.0 Suporta as funções RAID 0,1,10
LAN	Realtek RTL8111E	Auto negociação de 10 / 100 / 1000 Mb/s Capacidade semi/full-duplex
Codec de som	ALC892	Saída de áudio de 5.1 canais Suporta a especificação High-Definition Audio
Ranuras	Ranhura PCI x2 Ranhura PCI Express Gen2 x16 x1	



<b>ESPECIFICAÇÕES</b>			
Conectores na placa	Conector SATA	x6	Cada conector suporta 1 dispositivo SATA
	Conector do painel frontal	x1	Para suporte de várias funções no painel frontal
	Conector de áudio frontal	x1	Suporta a função de áudio no painel frontal
	Conector de saída S/PDIF	x1	Suporta a saída de áudio digital
	Conector da ventoinha da CPU	x1	Alimentação da ventoinha da CPU (com a função Smart Fan)
	Conector da ventoinha do sistema	x2	Alimentação da ventoinha do sistema
	Conector para limpeza do CMOS	x1	
	Conector USB	x3	Cada conector suporta 2 portas USB no painel frontal
	Conector da para impressora	x1	Cada conector suporta 1 Porta para impressora
	Porta série	x1	
	Conector de IR do consumidor	x1	
	Conector de alimentação (24 pinos)	x1	
	Conector de alimentação (4 pinos)	x1	
Entradas/Saídas no painel traseiro	Teclado / Rato PS/2	x1	
	Porta HDMI	x1	
	Porta VGA	x1	
	Porta DVI-D	x1	
	Porta LAN	x1	
	Porta USB	x4	
	Tomada de áudio	x3	
Tamanho da placa	233 mm (L) X 244 mm (A)		uATX
Sistemas operativos suportados	Windows XP / Vista / 7		A Biostar reserva-se o direito de adicionar ou remover suporte para qualquer sistema operativo com ou sem aviso prévio.

**POLISH**

<i>SPEC</i>		
Procesor	Socket AM3 AMD Sempron / Phenom II / Athlon II Procesory	Architektura AMD 64 umożliwia przetwarzanie 32 i 64 bitowe Obsługa Hyper Transport 3.0
FSB	Obsługa HyperTransport 3.0 o szerokości pasma do 5.2 GT/s	
Chipset	AMD 880G AMD SB710	
Pamięć główna	Gniazda DDR3 DIMM x 4 Maks. wielkość pamięci 16GB Każde gniazdo DIMM obsługuje moduły 512MB/1GB/2GB/4GB DDR3	Moduł pamięci DDR3 z trybem podwójnego kanału Obsługa DDR3 800 / 1066 / 1333 Obsługa DDR3 1600 (OC)
Grafika	AMD 880G (Radeon HD4250)	Maks. wielkość współdzielonej pamięci video wynosi 512 MB Wbudowany port stronie pamięci 128MB DDR3 Obsługa DVI/HDMI/UVD/HDCP
Super I/O	ITE 8721 Zapewnia najbardziej powszechne funkcje Super I/O. Interfejs Low Pin Count	Funkcje kontroli warunków pracy, Monitor H/W Kontroler prędkości wentylatora Funkcja ITE "Smart Guardian"
SATA 2	Zintegrowany kontroler Serial ATA	Transfer danych do 3 Gb/s. Zgodność ze specyfikacją SATA w wersji 2.0 Obsługa RAID 0,1,10
LAN	Realtek RTL8111E	10 / 100 / 1000 Mb/s z automatyczną negocjacją szybkości Działanie w trybie połowicznego/pełnego dupleksu
Kodek dźwiękowy	ALC892	5.1 kanałowe wyjście audio Obsługa High-Definition Audio
Gniazda	Gniazdo PCI x2 Gniazdo PCI Express Gen2 x16 x1	

**TA880GB+/TA880GB**

<i>SPEC</i>			
Złącza wbudowane	Złącze SATA	x6	Każde złącze obsługuje 1 urządzenie SATA
	Złącze panela przedniego	x1	Obsługa elementów panela przedniego
	Przednie złącze audio	x1	Obsługa funkcji audio na panelu przednim
	Złącze wyjścia S/PDIF	x1	Obsługa funkcji cyfrowego wyjścia audio
	Złącze główkowe wentylatora procesora	x1	Zasilanie wentylatora procesora (z funkcją Smart Fan)
	Złącze główkowe wentylatora systemowego	x2	Zasilanie wentylatora systemowego
	Złącze główkowe kasowania CMOS	x1	
	Złącze USB	x3	Każde złącze obsługuje 2 porty USB na panelu przednim
	Złącze Port drukarki	x1	Każde złącze obsługuje 1 Port drukarki
	Port szeregowy	x1	
	Złącze Konsument IR	x1	
	Złącze zasilania (24 pinowe)	x1	
Złącze zasilania (4 pinowe)	x1		
Back Panel I/O	Klawiatura / Mysz PS/2	x1	
	Port HDMI	x1	
	Port VGA	x1	
	Port DVI-D	x1	
	Port LAN	x1	
	Port USB	x4	
	Gniazdo audio	x3	
Wymiary płyty	233 mm (S) X 244 mm (W)	uATX	
Obsługa systemu operacyjnego	Windows XP / Vista / 7		Biostar zastrzega sobie prawo dodawania lub odwoływania obsługi dowolnego systemu operacyjnego bez powiadomienia.

**RUSSIAN**

<b>СПЕЦ</b>		
CPU (центральный процессор)	Гнездо AM3 Процессоры AMD Sempron / Phenom II / Athlon II	Архитектура AMD 64 разрешать обработка данных на 32 и 64 бит Поддержка Hyper Transport 3.0
FSB	Поддержка HyperTransport 3.0 с пропускной способностью до 5.2 GT/s	
Набор микросхем	AMD 880G AMD SB710	
Основная память	Слоты DDR3 DIMM x 4 Максимальная ёмкость памяти 16 ГБ Каждый модуль DIMM поддерживает 512МБ/1ГБ/2ГБ/4ГБ DDR3	Модуль памяти с двухканальным режимом DDR3 Поддержка DDR3 800 / 1066 / 1333 Поддержка DDR3 1600 (OC)
Графика	AMD 880G (Radeon HD4250)	Максимальная совместно используемая видео память составляет 512 МБ Бортовой номер порта на стороне памяти 128MB DDR3 Поддержка DVI/HDMI/UVD/HDCP
Super I/O	ITE 8721 Обеспечивает наиболее используемые действующие функциональные возможности Super I/O. Интерфейс с низким количеством выводов	Инициативы по охране окружающей среды, Аппаратный монитор Регулятор скорости Функция ITE "Smart Guardian" (Интеллектуальная защита)
SATA 2	Встроенное последовательное устройство управления ATA	скорость передачи данных до 3 гигабит/с. Соответствие спецификации SATA версия 2.0 Поддержка RAID 0,1,10
Локальная сеть	Realtek RTL8111E	Автоматическое согласование 10 / 100 / 1000 Мб/с Частичная / полная дуплексная способность
Звуковой кодек	ALC892	Звуковая поддержка High-Definition 5.1канальный звуковой выход
Слоты	Слот PCI x2 Слот PCI Express Gen2 x16 x1	

**TA880GB+/TA880GB**

<b>СПЕЦ</b>			
Встроенны й разъём	Разъём SATA	x6	Каждый разъём поддерживает 1 устройство SATA
	Разъём на лицевой панели	x1	Поддержка устройств на лицевой панели
	Входной звуковой разъём	x1	Поддержка звуковых функций на лицевой панели
	Разъём вывода для S/PDIF	x1	Поддержка вывода цифровой звуковой функции
	Контактирующее приспособление вентилятора центрального процессора	x1	Источник питания для вентилятора центрального процессора (с функцией интеллектуального вентилятора)
	Контактирующее приспособление вентилятора системы	x2	Источник питания для вентилятора системы
	Открытое контактирующее приспособление CMOS	x1	
	USB-разъём	x3	Каждый разъём поддерживает 2 USB-порта на лицевой панели
	Разъём Порт подключения принтера	x1	Каждый разъём поддерживает 1 Порт подключения принтера
	Последовательный порт	x1	
	Разъём едока ИКБЫЙ	x1	
	Разъём питания (24 вывод)	x1	
	Разъём питания (4 вывод)	x1	
Задняя панель средств ввода-выв ода	Клавиатура / Мышь PS/2	x1	
	Порт HDMI	x1	
	Порт VGA	x1	
	Порт DVI-D	x1	
	Порт LAN	x1	
	USB-порт	x4	
	Гнездо для подключения наушников	x3	
Размер панели	233 мм (Ш) X 244 мм (В)		uATX
Поддержка OS	Windows XP / Vista / 7		Biostar сохраняет за собой право добавлять или удалять средства обеспечения для OS с или без предварительного уведомления.

## ARABIC

المواصفات	
وحدة المعالجة المركزية	AM3 بمقياس AMD Sempron / Phenom II / Athlon II معالج AMD 64 بت يمكن تقنية Hyper Transport 3.0 دعم تقنية
النقل الأمامي الجانبي	5.2 GT/s يتردد يصل إلى HyperTransport 3.0 دعم تقنية
مجموعة التبريد	AMD 880G AMD SB710
الذاكرة الرئيسية	قناة DDR3 DIMM عدد 4 سعة ذاكرة قصوى 16 جيجا بايت ميجا بايت 512/سعة DDR3 دعم ذاكرة من نوع DIMM دعم كل قناة و1/2/4 جيجا بايت
بطاقة الرسومات	AMD 880G (Radeon HD4250) ميجا بايت 512 أقصى سعة لذاكرة الفيديو المشتركة 128MB DDR3 ذاكرة منفذ الجانب متن على HDCP/UVD/HDMI/DVI دعم تقنية
Super I/O	ITE 8721 الأكثر استخداماً Super I/O يوفر وظيفة Low Pin Count Interface دعم تقنية
SATA 2	متكامل Serial ATA متحكم 2.0 الإصدار SATA مطابقة المواصفات RAID 0,1,10 دعم تقنية
شبكة داخلية	Realtek RTL8111E تفاوض تلقائي 10/100 ميجا بايت / ثنائية و1 جيجا بت/ثنائية إمكانية النقل المزدوج الكامل/القصفي
كوديك الصوت	ALC892 تدعم تقنية الصوت عالي التعريف من 5.1 قنوات لخرج الصوت
الفتحات	قناة PCI عدد 2 قناة PCI Express Gen2 x16 عدد 1

TA880GB+/TA880GB

المواصفات		
منفذ SATA	عدد 6	منفذ SATA يدعم كل منفذ واحد من أجهزة SATA
منفذ اللوحة الأممية	عدد 1	يدعم تجهيزات اللوحة الأممية
منفذ الصوت الأممي	عدد 1	يدعم وظيفة الصوت باللوحة الأممية
منفذ خرج S/PDIF	عدد 1	يدعم وظيفة خرج الصوت الرقمي
وصلة مروحة وحدة المعالجة المركزية	عدد 1	Smart Fan لتوصيل الطاقة لمروحة وحدة المعالجة مع وظيفة
وصلة مروحة النظام	عدد 2	لتوصيل الطاقة لمروحة النظام
وصلة مسح CMOS	عدد 1	
منفذ USB	عدد 3	باللوحة الأممية USB يدعم كل منفذ قحني
منفذ طباعة	عدد 1	
منفذ تسلسلي	عدد 1	
منفذ الأحمر تحت مستهلكة	عدد 1	
منفذ توصيل الطاقة (24دبوس)	عدد 1	
منفذ توصيل الطاقة (4دبليس)	عدد 1	
لوحة مفاتيح / ملوس PS/2	عدد 1	
منافذ HDMI	عدد 1	
منافذ VGA	عدد 1	
منافذ DVI-D	عدد 1	
منفذ شبكة اتصال محلية	عدد 1	
منافذ USB	عدد 4	
مقيس صوت	عدد 3	
حجم اللوحة	233 مم (عرض) X 244 مم (ارتفاع)	uATX
دعم أنظمة التشغيل	Windows XP / Vista / 7	بحقها في إضافة أو إزالة الدعم لأي نظام تشغيل باخطار أو Biostar تحتفظ بدون إخطار .

**JAPANESE**

仕様		
CPU	Socket AM3 AMD Sempron / Phenom II / Athlon II プロセッサ	AMD 64アーキテクチャでは、32ビットと64ビット計算が可能です ハイパートランスポート3.0をサポートします
FSB	5.2 GT/sのバンド幅までハイパートランスポート3.0をサポートします	
チップセット	AMD 880G AMD SB710	
メインメモリ	DDR3 DIMMスロット x 4 最大メモリ容量16GB 各DIMMは 512MB/1GB/2GB/4GB DDR3をサポート	デュアル チャンネルモードDDR3 メモリモジュール DDR3 800 / 1066 / 1333 をサポート DDR3 1600 をサポート (OC)
グラフィックス	AMD 880G (Radeon HD4250)	最大の共有ビデオメモリは512MBです オンボード側のポートメモリは、128MBのDDR3 DVI/HDMI/UVD/HDCP のサポート
Super I/O	ITE 8721 もっとも一般に使用されるレガシーSuper I/O機能を採用しています。 低ピンカウントインターフェイス	環境コントロールイニシアチブ、 H/Wモニター ファン速度コントローラ/ モニター ITEの「スマートガーディアン」機能
SATA 2	統合シリアルATAコントローラ	最高3 Gb/秒のデータ転送速度 SATAバージョン2.0仕様に準拠。 RAID 0,1,10のサポート
LAN	Realtek RTL8111E	10 / 100 / 1000 Mb/秒のオートネゴシエーション 半/全二重機能
サウンドCodec	ALC892	ハイデフィニションオーディオのサポート 5.1 チャンネルオーディオアウト
スロット	PCIスロット x2 PCI Express Gen2 x16スロット x1	



**TA880GB+/TA880GB**

仕様			
オンボードコネクタ	SATAコネクタ	x6	各コネクタは1つのSATAデバイスをサポートします
	フロントパネルコネクタ	x1	フロントパネル機能をサポートします
	フロントオーディオコネクタ	x1	フロントパネルオーディオ機能をサポートします
	S/PDIFアウトコネクタ	x1	デジタルオーディオアウト機能をサポートします
	CPUファンヘッダ	x1	CPUファン電源装置(スマートファン機能を搭載)
	システムファンヘッダ	x2	システムファン電源装置
	CMOSクリアヘッダ	x1	
	USBコネクタ	x3	各コネクタは2つのフロントパネルUSBポートをサポートします
	プリンタポートコネクタ	x1	各コネクタは1つのプリンタポートをサポートします
	シリアルポート	x1	
	消費者IRコネクタ	x1	
	電源コネクタ(24ピン)	x1	
電源コネクタ(4ピン)	x1		
背面パネルI/O	PS/2キーボード / マウス	x1	
	HDMIポート	x1	
	VGAポート	x1	
	DVI-Dポート	x1	
	LANポート	x1	
	USBポート	x4	
	オーディオジャック	x3	
ボードサイズ	233 mm (幅) X 244 mm (高さ)	uATX	
OSサポート	Windows XP / Vista / 7		Biostarは事前のサポートなしにOSサポートを追加または削除する権利を留保します。

2010/05/21